



---

# 競賽規則與解釋說明

## COMPETITION RULES & INTERPRETATION

2023 年 1 月 27 日生效

In force as of January 27, 2023

---

中華民國跆拳道協會編譯

2023 年 2 月

Enacted: May 28 , 1973  
制定 : 5 。 28 , 1973  
Amended: Oct 。 1 , 1977  
修訂 : 10 。 1 , 1977  
Amended: Feb 。 23 , 1982  
修訂 : 2 。 23 , 1982  
Amended: Oct 。 19 , 1983  
修訂 : 10 。 19 , 1983  
Amended: June 1 , 1986  
修訂 : 6 。 1 , 1986  
Amended: Oct 。 7 , 1989  
修訂 : 10 。 7 , 1989  
Amended: Oct 。 28 , 1991  
修訂 : 10 。 28 , 1991  
Amended: Aug 。 17 , 1993  
修訂 : 8 。 17 , 1993  
Amended: Nov 。 18 , 1997  
修訂 : 11 。 18 , 1997  
Amended: Oct 。 31 , 2001  
修訂 : 10 。 31 , 2001  
Amended: Sep 。 23 , 2003  
修訂 : 9 。 23 , 2003  
Amended: April 12 , 2005  
修訂 : 4 。 12 , 2005  
Amended: February 13 , 2009  
修訂 : 2 。 13 , 2009  
Amended: March 2 , 2010  
修訂 : 3 。 2 , 2010  
Amended: October 7 , 2010  
修訂 : 11 。 7 , 2010  
Amended: April 30 , 2011  
修訂 : 4 。 30 , 2011  
Amended: October 4 , 2011  
修訂 : 10 。 4 , 2011  
Amended: April 3 , 2012  
修訂 : 4 。 13 , 2009  
Amended: December 26 , 2012  
修訂 : 12 。 26 , 2012  
Amended: July 14 , 2013  
修訂 : 7 。 14 , 2013  
Amended: March 19 , 2014  
修訂 : 3 。 19 , 2014  
Amended: October 30 , 2014  
修訂 : 10 , 30 2014  
Amended: May 11 , 2015  
修訂 : 5 , 11 , 2015  
Amended: Nov 15 , 2016  
修訂 : 11 , 15 , 2016  
Amended: APR 5 , 2018  
修訂 : 4 , 5 , 2018  
Amended: May 14 , 2019  
修訂 : 5 , 14 , 2019  
Amended: February 16 , 2022  
修訂 : 2 , 16 , 2022  
Amended: April 29 , 2022  
修訂 : 4 , 29 , 2022  
Amended: July 12 , 2022  
修訂 : 7 , 12 , 2022  
Amended: Jaunary 27 , 2023  
修訂 : 1 , 27 , 2023

©World Taekwondo Federation  
Seongnam , Korea All  
rights reserved  
Demcember 2016

Published by the World  
Taekwondo Federation  
Printed in Korea

# World Taekwondo Federation Competition Rules & Interpretation

## Table of Contents

### 世界跆拳道聯盟競賽規則解釋與說明

#### 目錄

第 1 條 目的	Article 1. Purpose	1
第 2 條 適用範圍	Article 2. Application	2
第 3 條 競賽場地	Article 3. Competition Area	3
第 4 條 競賽選手	Article 4. Contestant	8
第 5 條 量級區分	Article 5. Weight Division	15
第 6 條 競賽分類與方式	Article 6. Classification and methods of competition	18
第 7 條 競賽時間	Article 7. Duration of Contest	20
第 8 條 抽籤	Article 8. Drawing of Lots	21
第 9 條 過磅	Article 9. Weigh-in	22
第 10 條 競賽程序	Article 10. Procedure of the Contest	24
第 11 條 合法技術與有效得分區域	Article 11. Permitted techniques and area	27
第 12 條 有效得分	Article 12. Valid points	28
第 13 條 計分與公佈	Article 13. Scoring and publication	30
第 14 條 違規行為與罰則	Article 14. Prohibited acts and penalties	31
第 15 條 黃金得分與優勢判定	Article 15. Golden Point and decision of superiority	38
第 16 條 裁決	Article 16. Decisions	41
第 17 條 擊倒	Article 17. Knock down	45
第 18 條 擊倒事件的處理程序	Article 18. Procedure in the event of Knock down	46
第 19 條 暫停競賽的處理程序	Article 19. Procedure of suspending the match	50
第 20 條 技術官員	Article 20. Technical Officials	54
第 21 條 即時錄影重播	Article 21. Instant Video Replay	59
第 22 條 聽障跆拳道競賽	Article 22. Deaf-Taekwondo	63
第 23 條 制裁	Article 23. Sanctions	64
第 24 條 其他於規則中未定之事項	Article 24. Other matters not specified in the Rules	68

## Article 1 Purpose 第 1 條 目的

- 1 The purpose of the Competition Rules is to provide standardized rules for all levels of Championships promoted and/or recognized by the World Taekwondo Federation (hereafter WT), WT Continental Unions (hereafter CUs), or/and WT Member National Associations (hereafter MNAs); the Competition Rules is intended to ensure that all matters related to competitions are conducted in a fair and orderly manner.  
制定本競賽規則的目的是為了確保世界跆拳道聯盟與各會員國協會能夠公正順利的管理主辦與承辦競賽之相關事宜。

---

### (Interpretation) (說明)

The objective of Article 1 is to ensure the standardization of all Taekwondo competition worldwide. Any competition not following the fundamental principles of these rules cannot be recognized as Taekwondo competition.

制定第一條規則的目的是為了確保全世界跆拳道競賽得以統一的標準執行，任何違反本規則基本原則的競賽，皆不得被認證為跆拳道競賽。

---

## Article 2 Application 第 2 條 適用範圍

1. The Competition Rules shall apply to all the competitions to be promoted and/or recognized by the WT, each CU and MNA. any MNA wishing to modify some or any part of the Competition Rules must first gain the prior approval of the WT. In the case that a CU and/or a MNA violates the Competition Rules without prior approval of the WT, the WT may exercise its discretion to disapprove or revoke its approval of the concerned international tournament. In addition, the WT may take further disciplinary actions to the pertinent CU or MNA

本競賽規則應用於世界跆拳道聯盟、各洲聯盟與各會員國協會主辦或承辦之競賽，任何會員國協會若欲修改部分的競賽規則，皆須於事前取得世界跆拳道聯盟的認證，各洲聯盟或各會員國協會，若未事前經世界跆拳道聯盟許可而違反競賽規則，世界跆拳道聯盟可依其權責不予核准或駁回該賽事之申請，此外，世界跆拳道聯盟可對該洲聯盟或會員國協會採取進一步之制裁。

2. All competitions promoted or recognized by the WT and /or each CU and/or MNA shall observe the WT Statutes, the Bylaws of Dispute Resolution and Disciplinary Action, and all other pertinent rules and regulations.

所有關於賽事推廣、組織，或經由世界跆拳道聯盟認證的競賽，皆應當遵守跆拳道法規、爭議解決與紀律處分的章程，以及其他所有相關的規章制度。

3. All competitions promoted or recognized by the WT and /or each CU and/or MNA shall abide by the WT Medical Code and the WT Anti-Doping Rules.

所有世界跆拳道聯盟認證的競賽及/或各州聯盟及/或國家協會賽事推廣、組織，應當遵守世界跆拳道聯盟醫療法規與反興奮劑的規則。

---

### (Explanation#1) (解釋#1)

First gain the approval: Any organization desiring to make a change in any portion of the existing rules must submit to the WT the contents of the desired amendment along with the reasons for the desired changes. Approval for any changes in these rules must be received from the WT at least one month prior to the scheduled competition. WT can apply Competition Rules with modifications in its promoted Championships with the decision of the Technical Delegate after approval of the President.

事前取得認證:各組委會欲更動現行規則，應將預備更動的內容與修改理由合併檢送世界跆拳道聯盟。並應於賽前一個月收到世界跆拳道聯盟變更認證之回覆，始得以排定賽程。

---

## Article 3 Competition Area 第 3 條 競賽場地

1. The Contest Area shall have a flat surface without any obstructing projections, and be covered with an elastic and not slippery mat. The Contest Area may also be installed on a platform 0.6-1m high from the base, if necessary. The outer part of the Outer Line shall be inclined at a gradient of less than 30 degrees, for the safety of the contestants. One of the following shapes can be used for Contest Area.

競賽場地應設於一個無障礙的平面上，覆蓋具有彈性防滑地墊。如為必要，競賽場地亦可設置於離地面 0.6-1 公尺高度的平台上。平台邊界外部應以低於 30 度的坡度向下傾斜，以維護參賽選手的安全。可以選擇使用下列其中一種形狀的競賽場地。

### 1.1 Square-shape

The Competition Area is comprised of a Contest Area and a Safety Area. The square-shape Contest Area shall be 8m x 8m. Surrounding the contest area, approximately equidistant on all sides, shall be the Safety Area. The size of Competition Area (which envelopes the Contest Area and the Safety Area) shall be no smaller than 10m x 10m and no larger than 12m x 12m. If the Competition Area is on a platform, the Safety Area can be increased as needed to ensure the safety of contestants. The Contest Area and the Safety Area shall be different colors, as specified in the relevant competition's Operational Manual

#### 正方形賽場

競賽場地由競賽區與安全區所構成。方形狀競賽區為 8 公尺 x 8 公尺。賽區周邊，四面距離應相等，比賽區域周圍，四面邊界等距為安全區。競賽場地（競賽區和安全區）不應小於 10 公尺 x 10 公尺，不超過 12 公尺 x 12 公尺。如果競賽場地是在一個平台上，安全區可以依據需要增加範圍，以確保增加參賽運動員的安全性。依據競賽技術手冊規範，應以不同的顏色劃分競賽區和安全區。

### 1.2 Octagonal-shape

The Competition Area is comprised of a Contest Area and a Safety Area. The Competition Area shall be square shaped and the size shall be no smaller than 10mx10m and no larger than 12mx12m. At the center of the Competition Areas shall be the octagonal-shape Contest Area. The Contest Areas shall measure approximately 8m in diameter, and each side of the octagon shall have a length of approximately 3.3m. Between the outer line of the Competition area and the boundary line of the Contest area is the Safety Area. The Contest Area and the Safety Area shall be different colors, as specified in the relevant competition's Operational Manual.

#### 八角形賽場

競賽場地由競賽區與安全區所構成。競賽場地應為方形，尺寸不得小於 10 公尺 x 10 公尺不得大於 12 公尺 x 12 公尺。競賽場地的中央應為八角形的競賽區，該賽區直徑應為 8 公尺，八角形的每一側邊為 3.3 公尺的長度。競賽區域的外圍線和競賽區域的邊界線之間是為安全區域。依據競賽技術手冊規範，競賽區和安全區應以不同的顏色區分。

## 2 Indication of positions

### 位置標示

- 2.1 The outer line of the Contest Area shall be called the Boundary Line(s) and the outer line of the Competition Area shall be called the Outer Line(s).

競賽區域的外圍線應稱為邊界線 (Boundary Line) ，競賽場地的外圍線應稱為外圍線 (Outer Line)

- 2.2 The front outer line adjacent to the Recorder's Desk shall be called Outer Line #1, and Clockwise from Outer Line#1, the other lines shall be called Outer Lines #2, #3, and #4. The Bound a ry Line adjacent to the Outer Line #1 shall be called Boundary Line #1 and clockwise from Boundary Line #1, the other lines shall be called Boundary Lines #2, #3, and #4. In case of Octagonal Shape Contest Area, The Boundary Line adjacent to the Outer Line #1 shall be called Boundary Line #1 and clockwise from Boundary Line #1, the other lines shall be called Boundary Lines #2, #3, #4, #5, #6, #7, and #8.

與記錄器台相鄰的外線應稱為外線 #1，從外線 #1 順時針，其他線應稱為外線 #2、#3 和 #4。與外線#1 相鄰的邊界線稱為邊界線#1，從邊界線#1 順時針，其他邊界線應稱為邊界線#2、#3 和#4。在八角形形狀競賽區域的情況下，與外線#1 相鄰的邊界線應稱為邊界線 #1，從邊界線 #1 順時針，其他線應稱為邊界線 #2、#3、#4、#5、#6、#7 和 #8。

- 2.3 Positions of Referee and Contestant s at the beginning and end of the Match: The position of the Contestants shall be at the two opposing points, 1m from the center point of the Contest Area parallel to Outer Line #1. The Referee shall be positioned at a point 1.5m from the center of the Contest Area toward the Outer Line #3.

主審與選手於競賽開始與結束時的位置：參賽選手的位置應在兩個相對點，平行於外圍線 # 1 的競賽區的中心點 1 公尺處。主審位置是距競賽區的中心點朝向外圍線 # 3 的 1.5 公尺處。

- 2.4 Positions of Judges: The position of the 1 st Judge shall be located at a point in minimum 2 m from the corner of the Boundary Line #2. The position of the 2 nd Judge shall be located at a point in minimum 2 m outward from the center of the Boundary Line 5. The position of the 3 rd Judge shall be located at a point in minimum 2 m from the corner of the Boundary Line 8. In case of two Judges setting the position of the 1<sup>st</sup> Judge shall be located at a point in minimum 2m from the center of the Boundary Line 1 and the 2 nd Judge shall be located at a point in minimum 2 m from the center of the Boundary Line 5. The positions of Judges may be altered to facilitate media, broadcasting and/or sports presentation.

副審位置:一號副審的位置應設在距離#2 邊界線角落至少 2 米。二號副審的位置應位於距離#5 邊界線中心至少 2 米。三號副審的位置應位於距離#8 邊界線角落至少 2 米。如果使用兩名副審，一號副審的位置，應位於距離#1 邊界線中心至少 2 米處， 二號副審應位於距離#5 邊界線中心至少 2 米處。副審的位置可以配合媒體、廣播和/或體育介紹而改變

- 2.5 Position of Recorder & IVR: Position of Recorder & IVR shall be located at a point 2 m from the Outer Line #1. Position of Recorder may be altered to accommodate the environment of the venue and requirements from media broadcasting and/or sports presentation.

記錄與 IVR 即時錄像審議：記錄與 IVR 即時錄像審議的位置應設於外圍線 # 1 向外 2 公尺處，紀錄人員的位置可以改變，以配合媒體轉播與所要求運動演示場地的環境。

- 2.6 Positions of Coaches: The position of the Coaches shall be marked at a point in minimum 2 m or more from the center point of the Outer Line of each contestant's side. Position of the coaches may be altered to accommodate the environment of the venue and requirements from media

broadcasting and/or sports presentation.

指導教練的位置: 指導教練的位置應設於參賽選手同邊之外圍線中心點向外 2 公尺或更遠處，為配合媒體轉播與所要求或運動演示場地的要求，教練的位置可以改變。

- 2.7 Position of Inspection desk: The position of the Inspection Desk shall be near the entrance of the Competition Area for the inspection of the contestants' protective equipment.

檢錄台的位置: 檢驗台的位置應靠近競賽場地的入口以為參賽選手的防護裝備進行檢查。

---

(Explanation #1) (解釋#1)

Elastic mat: The degree of elasticity and slipperiness of the mat must be approved by the WT before the competition.

彈性地墊: 地墊的彈性與滑度必須在比賽前經由世界跆拳道聯盟檢驗認證核可。

(Explanation #2) (解釋#2)

Color: The color scheme of the mat's surface must avoid giving a harsh reflection, or tiring the contestant's or spectator's eyesight. The color scheme must also be appropriately matched to the contestant's equipment, uniform and the surface of the Contest Area

顏色: 地墊表面的配色必須避免銳利反光的色澤或是容易造成選手與觀眾視力疲勞的顏色。配色組合必須與運動員的裝備、服裝以及競賽場地周遭適切的相互契合。

(Explanation #3) (解釋#3)

Inspection Desk: At the Inspection desk, the inspector checks if all the materials worn by the contestant are approved by the WT and fit the contestant properly. In case they are found to be inappropriate, the contestant is requested to change the protective equipment.

檢錄台: 檢錄台的檢錄人員應檢查參賽選手是否合身穿著世界跆拳道聯盟所認證之裝備，若發現為不適當者，得要求其更換符合規範之裝備

---



## Octagonal-shape /八角形平台賽場

Octogonal mat on platform

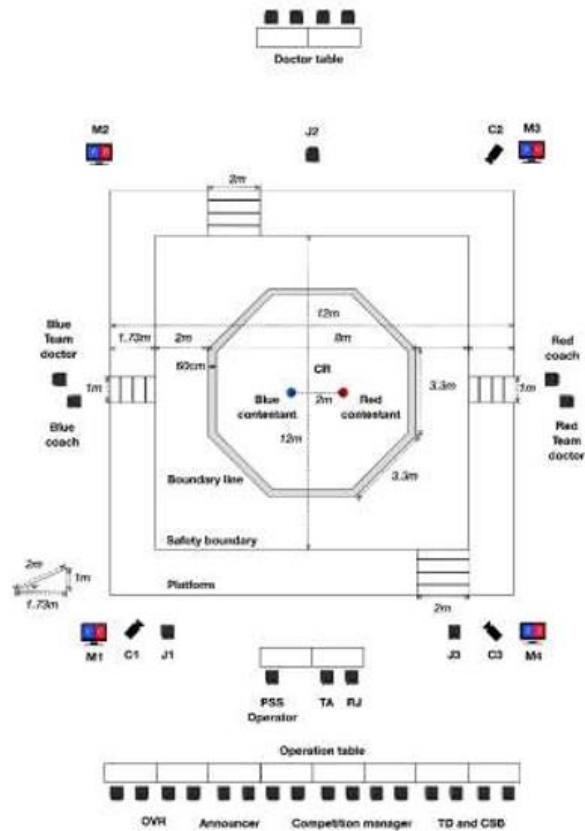

## Octagonal-shape /八角形賽場

Octogonal mat on floor

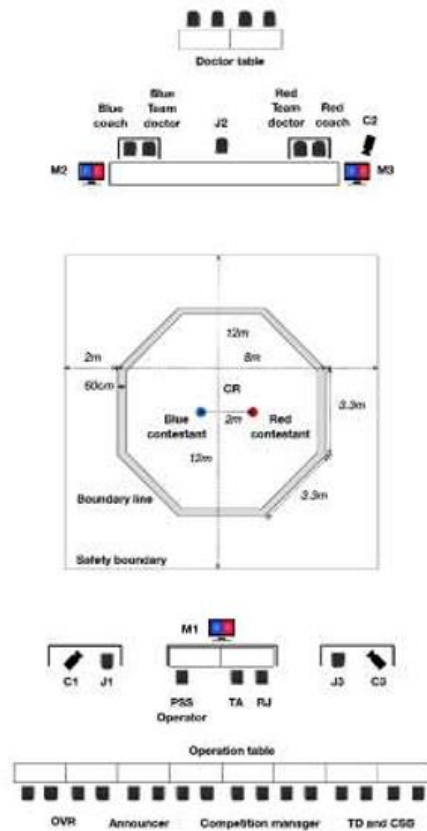

## Square-shape /正方形賽場

Square mat on platform

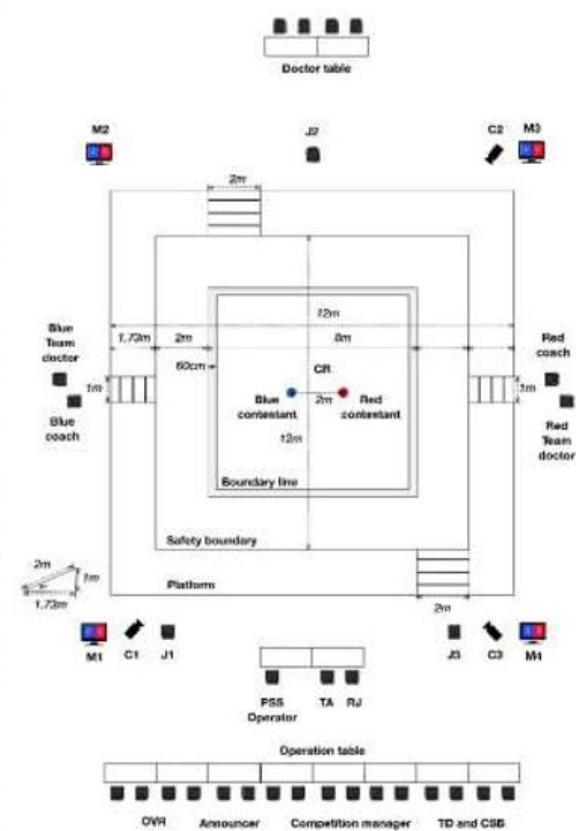

TD : Technical 技術代表  
 CSB: Competition Supervisory Board 競賽管理委員會  
 OVR : On Venue Result 即時成績

CR: Center Referee 主審  
 J1-J2-J3 : Corner Judge 副審  
 RJ : Review Jury 陪審

TA: Technical Assistant 技術助理  
 C1-C2-C3 : Camera 1,2 and3 攝影機 1、2、3 號  
 M1-M2-M3 : Scoreboard monitor 1.2.3 and 4 記分板 1、2、3、4

Octagonal-shape / 八角形平台賽場

Octagonal mat on platform

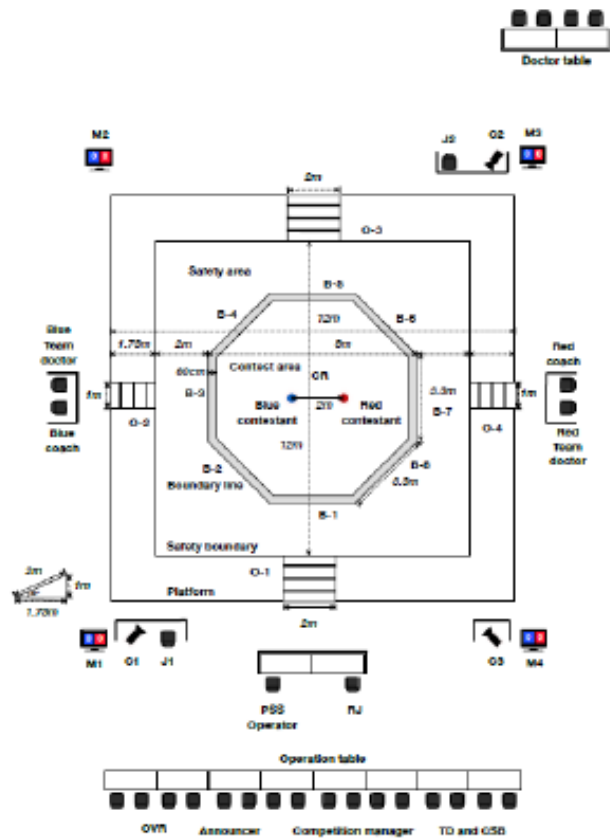

Octagonal-shape / 八角形賽場

Octagonal mat on floor

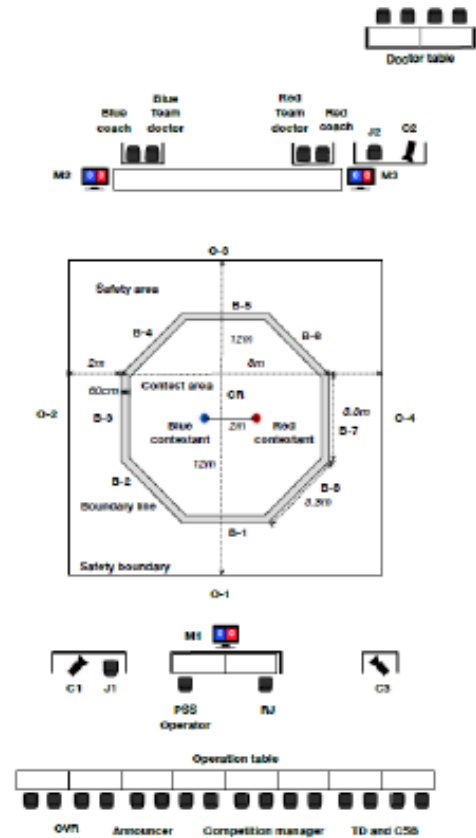

Square-shape / 正方形賽場

Square mat on platform

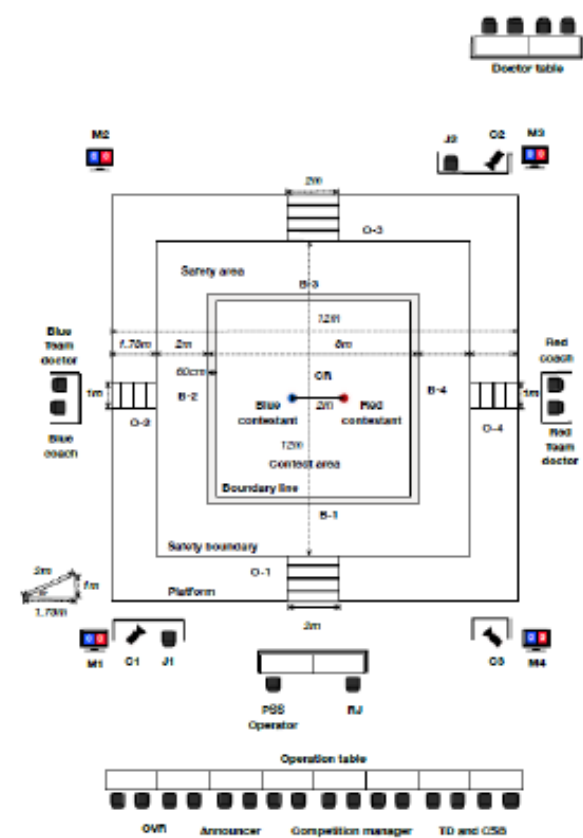

TD : Technical 技術代表  
 CSB: Competition Supervisory Board 競賽管理委員會  
 OVR : On Venue Result 即時成績

CR: Center Referee 主審  
 J1-J2 : Corner Judge 副審  
 RJ : Review Jury 陪審

TA: Technical Assistant 技術助理  
 C1-C2-C3 : Camera 1,2 and3 攝影機 1、2、3 號  
 M1-M2-M3 : Scoreboard monitor 1.2.3 and 4 記分板 1、2、3、4

八角形地墊 (0.8M)

八角形捲墊

八角形地墊 (1M)

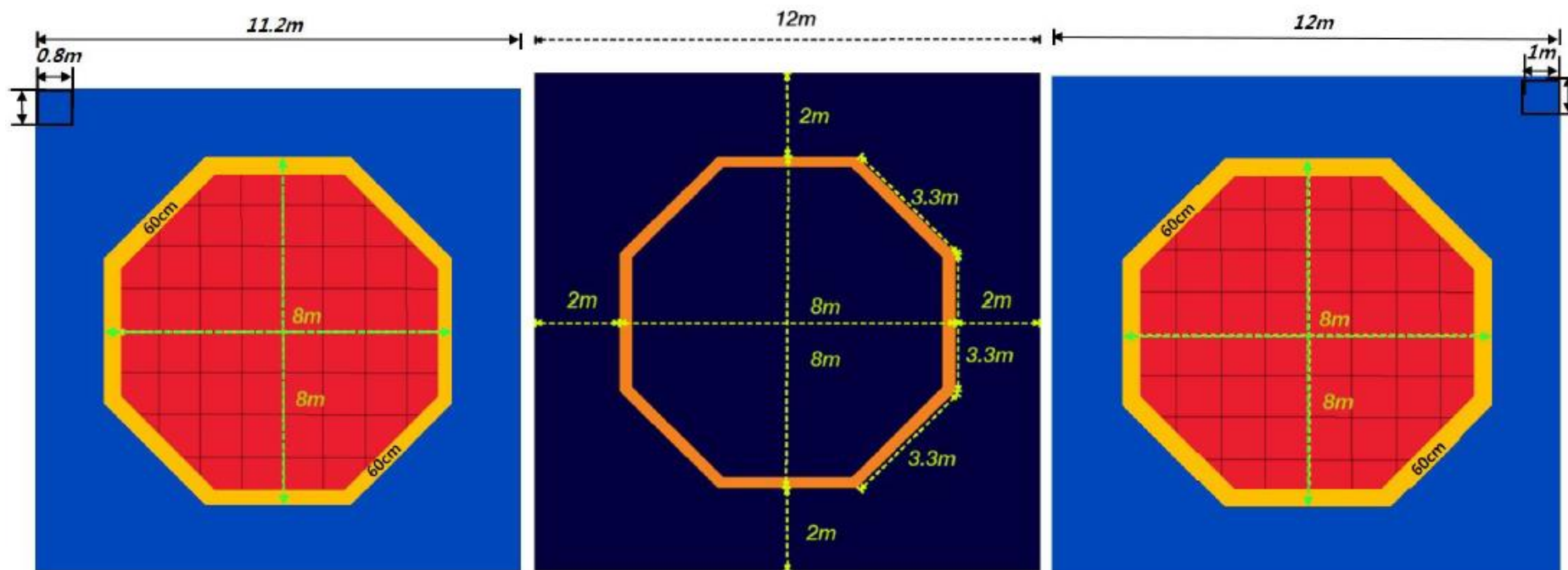

Octagonal mat (puzzle 0.8m)

Octagonal roll mat

Octagonal mat (puzzle 1.0m)

## Article 4 Contestant 第 4 條 競賽選手

### 1 Qualification of Contestant

參賽選手資格:

#### 1.1 Holder of the nationality of the participating team

擁有其參賽隊伍之國籍者。

#### 1.2 One recommended by the WT MNA

由世界跆拳道聯盟之會員國協會推薦者。

#### 1.3 Holder of Taekwondo Dan/Poom certificate issued by the Kukkiwon

持有國技院之段/品證者。

#### 1.4 Holder of the WT Global Athlete License (GAL)

持有世界跆拳道聯盟全球選手證(GAL)者。

#### 1.5 Contestants at the age of at least 17 years old for Senior in the year the pertinent tournament is held (15-17 years old for Junior Taekwondo Championships and 12-14 years old for Cadet Championships). Ages for Youth Olympic Games might be different depending on the decision of the IOC.

參賽選手年齡以舉辦年度計算，成年組的選手須年滿 17 歲，(青少年跆拳道錦標賽的參賽者為 15-17 歲，少年跆拳道錦標賽的參賽者為 12-14 歲)。青年奧運會參賽選手的年齡限制可能會有所不同，取決於國際奧林匹克委員會的決定。

#### (Interpretation) (說明)

The age limit is based on the year, not on the date. For instance, if the Junior Taekwondo Championships are held on June 11, 2013, those contestants born on between January 1, 1996 and December 31, 1998 are eligible to participate.

年齡限制是以年度為計算基點，而非日期。例如：如果世界青少年跆拳道錦標賽舉辦的日期為 2013 年 6 月 11 日，於 1996 年 1 月 1 日至 1998 年 12 月 31 日間出生的選手皆具有參賽資格。

#### (Interpretation) (說明)

Article 4.1 Qualification of Contestant: applied at WT promoted championships, CU promoted championships, multi-sports games, and approved event(s) of WT recognized international open taekwondo tournament

第 4.1 條 參賽者資格:適用在 WT 主辦錦標賽、洲際推廣錦標賽、綜合性運動會及經 WT 認證的國際跆拳道公開賽事。

#### (Interpretation) (說明)

Article 4.1.1 & 4.1.2 shall not be applied to open championships.

第 4 條第 1 款第 1 項及第 4 條第 1 款第 2 項不適用於公開賽事

### 2 Contestant uniform and competition equipment

選手的服裝與競賽裝備

- 2.1 At the competitions enlisted in the WT Event Calendar, contestant uniform and all competition equipment such as but not limited to mats, PSS, IVR and protective equipment must be those ones approved by the WT.

所有於世界跆拳道聯盟行事曆中公布之賽事，除了彈性地墊之外，選手的道服與所有競賽的器材，包含 PSS 電子護具系統、IVR 即時錄像審議系統和防護裝備皆必須經由世界跆拳道聯盟的認證。

- 2.1.1 Specifications of dobok or competition uniform protective equipment, and all other equipment shall be set forth separately.

道服或比賽統一防護裝備的規格及所有其他裝備應另行規定

- 2.2 A contestant shall wear a WT approved dobok or competition uniform, trunk PSS, head PSS groin guard, forearm guards, shin guards, gloves, sensing socks (in the case of using and be equipped with a mouthguard before entering the Field of Play. Head pss must be firmly tucked under left arms when entering into competition area. Head pss shall be put on the head following instructions of the referee before the start of the contest.

參賽者須穿著世界跆拳道聯盟所認證的道服或是制服、護具、頭盔、護襠、護肘、護脛、護手套、電子感應襪（使用電子護具系統的情況下），並應於進入競賽區之前配戴牙套。進入競賽區域時，頭部保護裝置的護頭盔必須夾置於左手臂下。於競賽開始前，應遵循主審指示戴上頭盔。

- 2.3 In case of wearing dobok, the forearm and shin guards shall be worn beneath garment. In case of wearing competition uniform, the forearm and shin guards shall be worn in the garment or beneath garment. The groin guards shall be worn beneath garment for both cases.

如果穿著道服，前臂和脛骨防護裝置應穿在衣服下面。在穿著比賽制服的情況下，前臂和脛骨防護裝置應穿在服裝裡或衣服裡面。對於兩種情況，護襠應穿在衣服裡面。

- 2.4 The contestant shall bring th e WT approved protective equipment, as well as gloves and the mouthguard, for his/her personal use. Wearing any item on the head other than the head pss shall not be permitted. The head protector for cadet athletes may be equipped with face shield. Any religious item shall be worn beneath the head PSS and inside the dobok or competition uniform and shall not cause harm or obstruct the opposing contestant.

參賽者應穿帶 WT 批准的防護裝備，以及手套和牙套，供他/她個人使用。除頭部 PSS 外，不得在頭上佩戴任何物品。少年組運動員的頭盔可配備面罩。任何宗教物品均應佩戴在 PSS 頭部下方以及道服或比賽制服內，不得對對方參賽者造成傷害或阻礙

- 2.5 Responsibilities of the organizing committee for competition equipment

籌備會負責之比賽相關器材

- 2.5.1 The Organizing Committee of WT-promoted Championships shall be responsible for preparing the following WT-recognized equipment for the use at the Championships at its own expenses for all related materials, equipment and the related technicians for installation and operation.

世界跆拳道聯盟認證之錦標賽籌備會應負責錦標賽使用世界跆拳道聯盟認可之相關器材、設備及相關技術人員於安裝與操作上的費用。

- Trunk PSS and Head PSS-related items and equipment – the choice of the PSS company shall be decided by the WT (For World Taekwondo Cadet Championships, conventional head protector with face shield shall be used)  
 電子護具、電子頭盔和其相關器材與設備的選擇由世界跆拳道聯盟決定。(世界少年錦標賽所規定的頭盔必須配有面罩)
- Mats  
 競賽地墊
- Other protective equipment as reserve (Sensing socks, gloves, shin guards, forearm guards, groin guards and dobok or competition uniforms)  
 其他防護裝備的準備 (電子感應襪、護手套、護脛、護肘、護襠以及跆拳道道服或制服)
- Instant Video Replay (IVR) system and its related equipment, including but not limited to cameras (minimum 3 cameras per court and minimum 4 cameras, including one overhead camera for the semifinals and final); When broadcasting is available, the broadcast feed must be made available at the Video Replay desk for review purpose. 4D replay system may be used for all championships G 12 grade and above for IVR.  
 即時錄影重播(IVR)系統與其相關設備，包含但不限於攝影機 (每一場地最少 3 台，準決賽與決賽最少 4 台攝影機，其中包括一台頂置式攝影機)。現場若有轉播影像，轉播影像須傳送到紀錄台提供錄像審議使用。在所有 G12 以上的錦標賽可提供 4D 影像回播系統供 IVR 使用
- Jumbo screen (for display of competition progress, match tree, athlete profile. Etc.) inside the Field of Play (FOP)  
 在競賽場地設置巨型螢幕(顯示進行中的比賽場次，對戰表及選手個人簡歷等資訊)
- Spectator scoreboards (for display of instant video replay screen; minimum 12)  
 觀眾區計分板(用於即時錄影重播的影像顯示，最少 12 台)
- Scoreboards at the court (for display of scoring; minimum 4 per court)  
 賽場計分顯示器 (用於計分顯示，每一個場地最少 4 台)
- Real Time Display System (RTDS) at athlete calling area and warm up area  
 選手呼叫區及準備區設置即時賽況顯示系統(RTDS)
- Real Time Referee Calling System (RTRCS) at referee lounge or waiting area.  
 裁判休息區或準備區設置即時裁判指派系統(RTRCS)
- TV screen for showing competitions in live at referee lounge

於裁判休息區設置電視螢幕撥放現場比賽情況

- Metal detector at the inspection desk (minimum 2)  
檢錄組金屬探測器(最少 2 支)
- Other competition equipment not prescribed in this article, if any, shall be described in shall be described in competitions Operational Manual of the WT.

如果有其他於本條文中未明文規定之競賽設備，應於世界跆拳道聯盟技術手冊說明。

- 2.5.2 The Organizing Committee of WT-promoted Championships shall be responsible for preparing the following equipment and materials, etc at the training venue at its own expenses.

世界跆拳道聯盟認證之錦標賽籌備會應負責提供的訓練場及準備以下設備和器材。

- Trunk PSS and/or Head PSS-related items and equipment  
電子護具、電子頭盔及其相關器材與設備
- Mats  
訓練場地地墊
- Stationary Bicycle  
固定式腳踏車
- Running Machine  
跑步機
- Emergency equipment (refer to medical code for detailed information)  
緊急設備(詳情請參閱醫療規章)
- Ice in the baskets  
冰塊及冰桶
- Refrigerators  
冰箱
- Bottled water  
瓶裝水

- 2.5.3 It is the responsibility of the Organizing Committee to obtain approval of the WT on the number of the equipment to be prepared.

準備世界跆拳道聯盟核定相關數量的器材與設備是籌備會的職責。

### 3 Anti-Doping Test

#### 運動禁藥管制

- 3.1 At the Taekwondo events promoted or recognized by the WT, any use or administration of drugs or chemical substances described in the WADA Prohibited List is prohibited. The WADA Anti-Doping Code shall be applied to the Taekwondo competitions of the Olympic Games and other multi-sports Games. The WT Anti-Doping Rules shall be applied to WT promoted and/or recognized championships.

在世界跆拳道聯盟主辦或認證的跆拳道賽事，使用世界反運動禁藥組織公布之運動禁藥清單中之藥物或化學合成物屬違規行為。奧林匹克運動會或其他綜合運動會跆拳道競賽適用世界反運動禁藥組織的運動禁藥規章。世界跆拳道聯盟運動禁藥規章適用於世界跆拳道聯盟主辦或認證的賽事。

- 3.2 The WT may carry out any doping tests deemed necessary to ascertain if a contestant has committed a breach of this rule, and any contestant who refuses to undergo this testing or who proves to have committed such a breach shall be removed from the final standings, and the record shall be transferred to the contestant next in line in the competition standings.

世界跆拳道聯盟有權以任何形式進行藥檢，選手若是違反運動禁藥規定或是獲獎選手拒絕藥檢，則取消其所得之名次，由次一名選手遞補。

- 3.3 The Organizing Committee shall be responsible for making all necessary preparations for conducting doping tests.

籌備會應負責進行運動禁藥檢測的準備工作。

- 3.4 The details of the WT Anti-Doping Rules shall be enacted as part of the bylaws.

世界跆拳道聯盟運動禁藥規章細節，應於附則中公布之。

---

(Explanation #1) (解釋#1)

Holder of the nationality of the participating team:

參賽隊伍國籍持有者:

When a contestant is a representative of a national team, his/her nationality is decided by citizenship of the country he/she is representing before submission of the application to participate. Verification of citizenship is done by inspection of the passport.

A competitor who is a national of two or more countries at the same time may represent either one of them, as he/she may elect. However, in case of changing nationality, he/she is allowed to represent other country only if thirty-six (36) months have passed since competitor represented a country in such events:

當選手代表一個國家，其國籍的判定是以選手報名參賽前是否擁有所代表國家之公民身分為依據，其公民身份驗證是透過護照檢查完成。

參賽選手同時擁有兩個或兩個以上的國籍，該選手可以選擇其國籍。然而，如果更換國籍，最後一次於下列項目代表國家參賽後，需經過 36 個月未曾代表過昔日所屬的國家參賽。

- i) Olympic Games  
奧林匹克運動會
- ii) Qualification Tournaments for Olympic Games  
奧林匹克運動會資格賽



- iii) 4 year cycle continental multi sports games  
4 年 1 次的綜合性運動會
- iv) 2 year cycle continental championships  
2 年 1 次的洲際錦標賽
- v) World Championships promote by WT  
世界跆拳道聯盟舉辦的世界錦標賽

This period may be reduced or even cancelled, with the agreement of the NOCs and the WT. The WT may take disciplinary actions at any time against the athlete and his/her MNA that violates this article including but not limited to deprivation of the achievements.

如為國家奧會與世界跆拳道聯之間的協議，這個期限可以縮短甚至取消。對選手與其國家協會違反本條規者，世界跆拳道聯盟隨時可採取紀律行動，但不限於所取得成績的剝奪。

(Explanation #2) (解釋#2)

One recommended by the WT MNA: Each MNA is responsible for control of non-pregnancy and gender and shall ensure that all team members have been given medical exams that show them to be of adequate health and fitness to participate. Also, each MNA assumes full responsibilities for accident and health insurance as well as the civil liabilities for their contestants and officials during the WT-promoted championships.

由世界跆拳道聯盟之會員國協會所推薦者: 各國家協會負責非孕期與性別問題的控制，並應確保所有隊員都接受醫療檢查並顯示他們都有健康的身心狀態。各國家協會亦自行負責提供他們參賽選手與隨隊官員在世界跆拳道聯盟主辦的錦標賽期間之意外與醫療保險，以及承擔民事上的法律責任。

(Explanation #3) (解釋#3)

Mouthguard:

The color of the mouthguard is limited to white or transparent. It must be at least 3mm thickness and cover entire upper teeth. Athletes with dental braces needs to wear special mouthguard for braces that covers both upper and lower teeth, recommended by their dentist and submit the letter from their dentist stating that the athlete is safe to compete with the mouthguard that the dentist recommended. (Refer to WT Mouthguard, Taping, Brace, Piercing rules for detailed)

牙套:

牙套的顏色僅限於白色或透明。必須至少 3 釐米公分厚。但是，如有提交醫生的診斷，該診斷指出使用牙套可能對參賽者造成傷害證明，可以免戴牙套。配戴矯正器的運動員需要佩戴特殊的牙套，覆蓋上排牙齒和下排牙齒，由牙醫推薦，並提交他們的牙醫的證明，說明運動員使用牙醫推薦的牙套參加比賽是安全的。（詳見 WT 牙套、貼紮、護具、穿孔規則）

(Explanation #4) (解釋#4)

Head PSS: The color of head PSS other than blue or red shall not be permitted to compete.

電子頭盔: 非藍色或紅色的其他顏色不允許出賽。

(Explanation #5) (解釋#5)

Instant Video Replay System: It is the responsibility of the Organizing Committee to ensure broadcasting feed is provided for Instant Video Replay for the matches requested by the WT.

即時錄影重播系統: 依據世界跆拳道聯盟要求，確保轉播影像可提供於錄像審議時使用，是籌備會的責任。

(Explanation #6) (解釋#6)

Taping: Taping of feet and hands will be strictly checked during the athlete inspection process. The inspector may request the WT Commission Doctor's approval for excessive taping. Contestants need to take off taping on general weigh-in to see whether there is any open wound, cut or bleeding. (Refer to WT Mouthguard, Taping, Brace, Piercing rules for detailed)

貼紮: 在運動員檢錄過程中，將嚴格檢查腳和手的貼紮。檢錄裁判可以要求 WT 委任醫生批准較多的貼紮。參賽者在過磅時需要摘除貼布，看看是否有任何開放傷口，割傷或出血（詳見 WT 牙套、貼紮、護具、穿孔規則細節）

(Explanation #7)(解釋 #7)

Any athlete who fails to wear appropriate safety protection gear and equipment or remove potentially harmful material from their body at the inspection as below (1) ~ (3) shall not be allow to participate in the competition. (Refer to WT Mouthguard, Taping, Brace, piercing rules and WT Medical Code Appendix III for detailed information.)

在下列(1)~(3)項檢查中，未穿戴適當安全防護裝備或從體內清除潛在有害物質的運動員，不得參加比賽。(有關詳細資訊，請參閱 WT 牙套，貼紮，護具，穿孔規則和 WT 醫療代碼附錄 III)。

- (1) Any athlete whose protection gear (such as head, body, groin, hand, foot protector and mouthguard) has either inadequate body part coverage by the gear, inappropriate size, or significant defect of shape (or material).

任何運動員的防護裝備（如頭部、身體、襠部、手部、腳步護具和牙套）的身體部位被裝備遮蓋不足、尺寸不合適或形狀（或材料）明顯缺陷。

- (2) Any athlete who does not have proper mouthguard per WT mouthguard rules at the inspection and does not have proper mouthguard at any time during the match, or fail to wear proper mouthguard despite of receiving a warning by an inspection referee, center referee or WT commissioned doctor.

任何運動員在檢查時沒有按照 WT 牙套規則配戴適當的牙套，並且在比賽期間的任何時候都沒有配戴合適的牙套，或者儘管收到檢查裁判，主審或 WT 委託醫生的警告，但未能配戴適當的牙套。

- (3) Any athlete who has piercing, earing or any hard material in the face or any body part at the inspection or during the match despite of receiving a warning by an inspection referee, center referee or WT commissioned doctor.

儘管收到檢錄裁判，主審或 WT 大會醫生的警告，任何運動員在檢查時或比賽期間臉部或任何身體部位仍穿戴有穿孔，耳朵等任何硬質材料。

(Explanation #8) (解釋 #8)

Any athlete who participate in competition must have valid annual periodic health evaluation (or medical certificate). Without valid annual Medical Certificate shall not be allowed to participate in the competition Medical Certificate. (Refer to WT medical code 8.3. Periodic Health Evaluation and Appendix III A. Medical Certificate for detailed information)

任何參加比賽的運動員必須持有有效的年度定期健康評估（或醫療證明）。沒有有效的年度醫療證明書，不得參加比賽。（請參閱 WT 醫療規章 8.3。定期健康評估和附錄 III A.醫療證明以獲取詳細資訊）

(Explanation #9) (解釋 #9)

Any athlete shall be disqualified for participation in competition if the athlete does not follow the safety protection equipment rule, has any health conditions that may jeopardized the safety by jurisdiction or have disqualifying conditions in the medical certificate. (refer to WT medical code Appendix III B. Disqualification for detailed information)

運動員不遵守安全防護裝備規則，或有可能危害安全的健康情況，或者醫療證明上有不合格條件，將被取消參賽資格。（詳情請參閱 WT 規章代碼附錄 III B.取消資格）

(Explanation #10) (解釋 #10)

Any athlete must have valid travel health insurance for the competition to participate and submit the copy of the health insurance certificate to GMS upon registration.

任何運動員必須持有有效的旅行健康保險才能參加比賽，並在註冊時向 **GMS** 提交健康保險證書副本

## Article Weight Division 第 5 條 量級區分

### 1. World Weight categories are divided into men's and women's divisions, and classified into as follows:

世界量級男子與女子量級區分如下:

Men's division 男子組		Women's division 女子組	
Under 54kg 54 公斤級以下	Not exceeding 54kg 54 公斤以下	Under 46kg 46 公斤級以下	Not exceeding 46 kg 46 公斤以下
Under 58kg 58 公斤級以下	Over 54 kg & Not exceeding 58 kg 54 公斤以上 58 kg 以下	Under 49kg 49 公斤級以下	Over 46 kg & Not exceeding 49 kg 46 公斤以上 49 公斤以下
Under 63kg 63 公斤級以下	Over 58 kg & Not exceeding 63 kg 58 公斤以上 63 kg 以下	Under 53kg 53 公斤級以下	Over 49 kg & Not exceeding 53 kg 49 公斤以上 53 公斤以下
Under 68kg 68 公斤級以下	Over 63 kg & Not exceeding 68 kg 63 公斤以上 68 kg 以下	Under 57kg 57 公斤級以下	Over 53 kg & Not exceeding 57 kg 53 公斤以上 57 公斤以下
Under 74kg 74 公斤級以下	Over 68 kg & Not exceeding 74 kg 68 公斤以上 74 kg 以下	Under 62kg 62 公斤級以下	Over 57 kg & Not exceeding 62 kg 57 公斤以上 62 公斤以下
Under 80kg 80 公斤級以下	Over 74 kg & Not exceeding 80 kg 74 公斤以上 80 kg 以下	Under 67kg 67 公斤級以下	Over 62 kg & Not exceeding 67 kg 62 公斤以上 67 公斤以下
Under 87kg 87 公斤級以下	Over 80 kg & Not exceeding 87 kg 80 公斤以上 87 kg 以下	Under 73kg 73 公斤級以下	Over 67 kg & Not exceeding 73 kg 67 公斤以上 73 公斤以下
Over 87kg 87 公斤以上	Over 87 kg 87 公斤以上	Over 73kg 73 公斤以上	Over 73 kg 73 公斤以上

### 2. Olympic Weight categories are classified as follows:

奧運量級區分如下:

Men's division 男子組		Women's division 女子組	
Under 58kg 58 公斤級以下	Not exceeding 58kg 58 公斤以下	Under 49kg 49 公斤級以下	Not exceeding 49kg 49 公斤以下
Under 68kg 68 公斤級以下	Over 58kg & not exceeding 68kg 58 公斤以上 68 公斤以下	Under 57kg 57 公斤級以下	Over 49kg & not exceeding 57kg 49 公斤 57 公斤以下
Under 80kg 80 公斤級以下	Over 68kg & not exceeding 80kg 68 公斤以上 80 公斤以下	Under 67kg 67 公斤級以下	Over 57kg & not exceeding 67kg 57 公斤 67 公斤以下
Over 80kg 80 公斤以上	Over 80kg 80 公斤以上	Over 67kg 67 公斤以上	Over 67kg 67 公斤以上

### 3. Junior Weight categories are classified as follows:

青少年組量級區分如下:

Men's division 男子組		Women's division 女子組	
Under 45kg 45 公斤級以下	Not exceeding 45kg 45 公斤以下	Under 42kg 42 公斤級以下	Not exceeding 42 kg 42 公斤以下
Under 48kg 48 公斤級以下	Over 45 kg & Not exceeding 48 kg 45 公斤以上 48 公斤以下	Under 44kg 44 公斤級以下	Over 42 kg & Not exceeding 44 kg 42 公斤以上 44 公斤以下
Under 51kg 51 公斤級以下	Over 48 kg & Not exceeding 51 kg 48 公斤以上 51 公斤以下	Under 46kg 46 公斤級以下	Over 44 kg & Not exceeding 46 kg 44 公斤以上 46 公斤以下
Under 55kg 55 公斤級以下	Over 51 kg & Not exceeding 55 kg 51 公斤以上 55 公斤以下	Under 49kg 49 公斤級以下	Over 46 kg & Not exceeding 49 kg 46 公斤以上 49 公斤以下

Under 59kg 59 公斤級以下	Over 55 kg & Not exceeding 59 kg 55 公斤以上 59 公斤以下	Under 52kg 52 公斤級以下	Over 49 kg & Not exceeding 52 kg 49 公斤以上 52 公斤以下
Under 63kg 63 公斤級以下	Over 59 kg & Not exceeding 63 kg 59 公斤以上 63 公斤以下	Under 55kg 55 公斤級以下	Over 52 kg & Not exceeding 55 kg 52 公斤以上 55 公斤以下
Under 68kg 68 公斤級以下	Over 63 kg & Not exceeding 68 kg 63 公斤以上 68 公斤以下	Under 59kg 59 公斤級以下	Over 55 kg & Not exceeding 59 kg 55 公斤以上 59 公斤以下
Under 73kg 73 公斤級以下	Over 68 kg & Not exceeding 73 kg 68 公斤以上 73 公斤以下	Under 63kg 63 公斤級以下	Over 59 kg & Not exceeding 63 kg 59 公斤以上 63 公斤以下
Under 78kg 78 公斤級以下	Over 73 kg & Not exceeding 78 kg 73 公斤以上 78 公斤以下	Under 68kg 68 公斤級以下	Over 63 kg & Not exceeding 68 kg 63 公斤以上 68 公斤以下
Over 78kg 78 公斤以上	Over 78 kg 78 公斤以上	Over 68kg 68 公斤級以上	Over 68 kg 68 公斤以上

#### 4. Youth Olympic Weight categories are classified as follows:

青年奧林匹克運動會量級區分如下:

Men's division 男子組		Women's division 女子組	
Under 48kg 48 公斤級以下	Not exceeding 48kg 48 公斤以下	Under 44kg 44 公斤級以下	Not exceeding 44kg 44 公斤以下
Under 55kg 55 公斤級以下	Over 48kg & not exceeding 55kg 48 公斤以上 55 公斤以下	Under 49kg 49 公斤級以下	Over 44kg & not exceeding 49kg 44 公斤以上 49 公斤以下
Under 63kg 63 公斤級以下	Over 55kg & not exceeding 63kg 55 公斤以上 63 公斤以下	Under 55kg 55 公斤級以下	Over 49kg & not exceeding 55kg 49 公斤以上 55 公斤以下
Under 73kg 73 公斤級以下	Over 63kg & not exceeding 73kg 63 公斤以上 73 公斤以下	Under 63kg 63 公斤級以下	Over 55kg & not exceeding 63kg 55 公斤以上 63 公斤以下
Over 73kg 73 公斤級以上	Over 73kg 73 公斤級以上	Over 63kg 63 公斤級以上	Over 63kg 63 公斤級以上

#### 5. Cadet Weight categories are classified as follows:

少年組量級區分如下:

Men's division 男子組		Women's division 女子組	
Under 33kg 33 公斤級以下	Not exceeding 33kg 33 公斤以下	Under 29kg 29 公斤級以下	Not exceeding 29kg 29 公斤以下
Under 37kg 37 公斤級以下	Over 33kg & not exceeding 37kg 33 公斤以上 37 公斤以下	Under 33kg 33 公斤級以下	Over 29kg & not exceeding 33kg 29 公斤以上 33 公斤以下
Under 41kg 41 公斤級以下	Over 37kg & not exceeding 41kg 37 公斤以上 41 公斤以下	Under 37kg 37 公斤級以下	Over 33kg & not exceeding 37kg 33 公斤以上 37 公斤以下
Under 45kg 45 公斤級以下	Over 41kg & not exceeding 45kg 41 公斤以上 45 公斤以下	Under 41kg 41 公斤級以下	Over 37kg & not exceeding 41kg 37 公斤以上 41 公斤以下
Under 49kg 49 公斤級以下	Over 45kg & not exceeding 49kg 45 公斤以上 49 公斤以下	Under 44kg 44 公斤級以下	Over 41kg & not exceeding 44kg 41 公斤以上 44 公斤以下
Under 53kg 53 公斤級以下	Over 49kg & not exceeding 53kg 49 公斤以上 53 公斤以下	Under 47kg 47 公斤級以下	Over 44kg & not exceeding 47kg 44 公斤以上 47 公斤以下
Under 57kg 57 公斤級以下	Over 53kg & not exceeding 57kg 53 公斤以上 57 公斤以下	Under 51kg 51 公斤級以下	Over 47kg & not exceeding 51kg 47 公斤以上 51 公斤以下
Under 61kg 61 公斤級以下	Over 57kg & not exceeding 61kg 57 公斤以上 61 公斤以下	Under 55kg 55 公斤級以下	Over 51kg & not exceeding 55kg 51 公斤以上 55 公斤以下
Under 65kg 65 公斤級以下	Over 61kg & not exceeding 65kg 61 公斤以上 65 公斤以下	Under 59kg 59 公斤級以下	Over 55kg & not exceeding 59kg 55 公斤以上 59 公斤以下
Over 65kg 65 公斤級以上	Over 65kg 65 公斤級以上	Over 59kg 59 公斤級以上	Over 59kg 59 公斤級以上

## 5.1 Cadet Height categories are classified as follow:

少年組身高量級區分如下:

Men's division 男子組			
Cadet contestant hight 少年選手身高		MAX Weight 最重體重	MIN weight 最輕體重
Under 148 cm/148 公分以下	Not exceeding 148cm	45kg	33kg
Under 152 cm/152 公分以下	Over 148 cm & not exceeding 152cm	48kg	35kg
Under 156 cm/156 公分以下	Over 152cm & not exceeding 156cm	51kg	37kg
Under 160 cm/160 公分以下	Over 156 cm & not exceeding 160cm	53kg	39kg
Under 164 cm/164 公分以下	Over 160cm & not exceeding 164cm	56kg	41kg
Under 168 cm/168 公分以下	Over 164 cm & not exceeding 168cm	59kg	43kg
Under 172 cm/172 公分以下	Over 168 cm & not exceeding 172cm	61kg	45kg
Under 176 cm/176 公分以下	Over 172 cm & not exceeding 176cm	64kg	47kg
Under 180 cm/180 公分以下	Over 176 cm & not exceeding 180cm	67kg	49kg
Over 180 cm/180 公分以上	Over 180cm	80 kg	52kg

Women's division 女子組			
Cadet contestant hight 少年選手身高		MAX Weight 最重體重	MIN weight 最輕體重
Under 144 cm/144 公分以下	Not exceeding 144cm	43kg	32kg
Under 148 cm/148 公分以下	Over 144 cm & not exceeding 148cm	45kg	33kg
Under 152 cm/152 公分以下	Over 148cm & not exceeding 152cm	48kg	35kg
Under 156 cm/156 公分以下	Over 152 cm & not exceeding 156cm	51kg	37kg
Under 160 cm/160 公分以下	Over 156cm & not exceeding 160cm	53kg	39kg
Under 164 cm/164 公分以下	Over 160 cm & not exceeding 164cm	56kg	41kg
Under 168 cm/168 公分以下	Over 164cm & not exceeding 168cm	59kg	43kg
Under 172 cm/172 公分以下	Over 168 cm & not exceeding 172cm	61kg	45kg
Under 176cm/176 公分以下	Over 172 cm & not exceeding 176cm	64kg	47kg
Over 176cm/176 公分以上	Over 176 cm	75 kg	50kg

## 6. Team Weight range are classified as follows.

### 團體量級範圍分級

Division 量級	Male team 男子組	Female team 女子組	Mix Gender Team 混合組
Maximum number of athletes 運動員最多參賽人數	4	4	4 (Maximum 2 male & 2 female)
Total weight range 總體重範圍	300kg or less 300 公斤或更少	260kg or less 260 公斤或更少	2 female athletes: 135kg or less 2 位女子運動員：135 公斤 2 male athletes: 160kg or less 2 位男子運動員：160 公斤

\* Substitute athlete(s) shall be participated in the weigh-in.

替補選手應參加過磅

\*\* If the existing athlete(s) is replaced by substitute athlete(s), the total weight of four athletes including the substitute athlete(s), excluding the replaced existing athlete(s), shall be recalculated and applied.

如現有運動員被替補運動員取代，則包括替補運動員在內的四名運動員的總體重（不包括被替換的現有運動員）應重新計算和應用。

#### (Explanation #1) (解釋#1)

Not exceeding:

The weight limit is defined by the criterion of one decimal place away from the stated limit. For example, not exceeding 50kg is established as until 50.0kg with 50.1kg being over the limit and resulting in disqualification.

“未超過體重上限”：

重量限制的基準是到小數點第一位。例如：50 公斤以下是指到 50.0 公斤，50.1 公斤則是超過了體重上限，將被取消參賽資格。

#### (Explanation #2) (解釋#2)

Over:

Over 50.00 kg marks occur at the 50.1kg reading and 50.0kg and below is regarded as insufficient, resulting in disqualification.

“達體重下限”：

50.00 公斤以上是以 50.1 公斤為起始重量，50.0 公斤及以下的重量則被視為不足，將導致被取消參賽資格。

## Article 6 Classification and methods of competition 第 6 條 競賽分類與方式

### 1. Competitions are classified as follows

競賽分類如下：

- 1.1 Individual competition shall normally be between contestants in the same weight category. When necessary, adjoining weight class may be combined to create a single classification. No contestant is allowed to participate in more than one (1) weight category in one event.

個人競賽通常是相同量級選手之間的競技，必要時，可將相鄰的量級合併，設置單一量級，在同一競賽項目中，選手只得參加一個量級的競賽。

- 1.2 Team Competition: Method and weight category of team competition shall be stipulated in the Standing Procedures for World Taekwondo Team Championships.

團體競賽：競賽方式與量級區分，WT 團體錦標賽應依據其最新的常設規程之規定。

### 2 Systems of competition are divided as follows.

競賽賽制分類如下：

#### 2.1 elimination tournament system

單敗淘汰賽制

#### 2.2 Round robin sys Single tem

循環賽制

- 3 Taekwondo competition of the Olympic Games and 4 year cycle continental multi sports games may use single elimination tournament system or the combination of single elimination tournament system with repechage.

奧林匹克運動會和四年一次的綜合性運動會跆拳道競賽可採行單敗淘汰賽或單淘汰賽結合敗部復活賽的複合賽制。

All international-level competitions recognized by the WT shall be formed with participation of at least four (4) countries in tournament with no less than four (4) contestants competed in each weight category, and any tournament with less than four (4) countries or weight category with less than 4 competed contestants cannot be recognized in the official results.

所有經世界跆拳道聯盟認證的國際賽事，應至少要有四個以上的參賽國家且每個量級至少要有四名以上的選手出賽，如果比賽少於四個國家參賽，或量級少於四名選手出賽，則該量級競賽的結果將不被列為正式成績紀錄。

- 4 World Taekwondo Grand Prix Series will be organized based on the most recent Standing Procedure of World Taekwondo Grand Prix Series.

世界跆拳道大獎系列賽將依據其最新的常設規程舉辦。

---

(Interpretation)(說明)

1. In the tournament system, competition is founded on an individual basis. However, the team standing can also be determined by the sum of the individual standings according to the overall scoring method.



在賽制方面是以個人賽制為設計基礎。但是團體名次可以依據個人賽的成績表現，以各量級之個人積分的總和，來決定團體成績的名次。

**\*Team standing**

Team standing shall be decided by the total points based on the following criteria.

團體排名

依據下列計分方式計算團體成績排名順序。

- Basic one (1) point per each contestant who entered the competition area after passing the general weigh-in  
選手過磅合格後進入競賽場地，得獲得基本分數 1 分。
- One (1) point per each win (win by a bye included)  
獲勝一場競賽得 1 分(包含因輪空獲勝)。
- Additional one hundred and twenty (120) points per gold medal  
獲得 1 面金牌得 120 分。
- Additional fifty (50) points per silver medal  
獲得 1 面銀牌得 50 分。
- Additional twenty (20) point per bronze medal  
獲得 1 面銅牌得 20 分。

In case more than two (2) teams are tied in score, the rank shall be decided by 1) number of gold, silver and bronze medals won by the team in order, 2) number of participating contestants and 3) higher points in heavier weight categories.

若有兩隊以上的積分相同，決定名次的方式依序為:1) 按各隊所獲得金、銀、銅牌數目之決定。2) 以各隊參賽人數的決定。3) 以較重量級者所得積分的決定

In the team competition system, the outcome of each team competition is determined by the individual team results.

在團體賽制中，各隊成績結果，取決於個人競賽成績的表現。

(Explanation #1) (解釋#1)

Consolidated weight divisions:

The method of consolidation shall follow the Olympic weight divisions.

合併量級:

合併量級方式應依照奧林匹克運動會量級區分的模式。

## Article 7 Duration of Contest 第 7 條 競賽時間

### 1 Duration of Contest is classified as follows

1.1 The duration of the contest shall be three rounds of two minutes each, with a one-minute rest period between rounds. In case of a tie score after the completion of the 3rd round, a 4th round of one minute will be conducted as the Golden round, after a one-minute rest period following the 3rd round.

競賽時間應為二分鐘三回合，回合間休息一分鐘，若三回合競賽結果為平手，應於休息一分鐘後，進行第四回合一分鐘的黃金回合賽。

1.2 In the best of three (3) system, the duration of the contest shall be three rounds of two minutes each with a one-minute rest period between rounds. However, a 4th round of one minute will not be conducted as the Golden round. In case of a tie score for corresponding round, the round winner shall be decided by the Article 15.

在 3 戰 2 勝賽制中，比賽的時間應為三回合，每回合兩分鐘，每回合間有一分鐘的休息時間。然而，將不舉行一分鐘的黃金回合賽。如果該回合出現平手，該回合優勝者依據第 15 章規定決定之。

1.3 In the World Cup Team Championships, the duration of the contest shall be three rounds of four (4) minutes of 1st round, five (5) minutes of 2nd and 3rd round with a one (1) minute rest period between rounds. The 1st round shall be conducted based on traditional team match format for one (1) minute per contest and the 2<sup>nd</sup> and the 3<sup>rd</sup> round shall be conducted for five (5) minutes based on tag-team match format

在世界盃團體賽，比賽時間應為三回合，第一回合為 4 分鐘，第二回合及第三回合為 5 分鐘，回合間休息時間回一分鐘。第一回合以傳統賽制為主，每位選手須上場一分鐘競賽。第二回合及第三回合則以擊掌方式為主的賽制。

2. The duration of each round may be adjusted to 1 minute x 3 rounds, 1 minute 30 seconds x 3 rounds, 2 minutes x 2 rounds or 5 minute x 1 round (with 1 time out for 30 seconds to each contestant) upon the decision of the Technical Delegate for the pertinent championships

每回合競賽時間可由相關錦標賽技術代表決定採用一分鐘三回合、一分三十秒三回合、二分鐘二回合或是五分鐘一回合(每位參賽者有一次 30 秒暫停時間)。

## Article 8 Drawing of Lots 第 8 條 抽籤

1. The date of the drawing of lots shall be set forth in the outline of the championships. At least one representative from each team must attend the drawing of lots and participating teams are responsible for confirming their entries before the drawing of lots. In case of no representative can be at the drawing of lots, the team must designate a proxy and inform Technical Delegate before the drawing of lots.

抽籤的日期應載於競賽規程，每一參賽隊伍應指派代表參加抽籤會議在抽籤前確認參賽人員。如果無法派人參加抽籤會議，必須於抽籤前指定代理人並通知技術代表。

2. The drawing of lots may be conducted by random computerized drawing or by random manual drawing of lots. The method and order of drawing shall be determined by the Technical Delegate.

抽籤可採用電腦隨機抽樣或人工隨機抽籤的方式進行。抽籤的方法與順序，由技術代表決定。

3. A certain number of contestants shall be seeded based on the WT Ranking. The number of contestants seeded shall be set forth in the Standing Procedures of the championships or in the Outline of the championships. In all WT recognized events a minimum 25% of contestants shall be seeded.

應依據世界跆拳道聯盟常設錦標賽或競賽規程規定的排名規章，將一定數量的參賽者列為種子選手。所有世界跆拳道聯盟認證賽事應設置至少 25% 種子選手。

## Article 9 Weigh-in 第 9 條 過磅

1. The general weigh-in of the contestants on the day of competition shall be organized one day prior to the competition. The time for the general weigh-in will be decided by the Organizing Committee and be informed at the head of team meeting. The duration of the general weigh-in shall be two (2) hours at the maximum.

參賽選手的正式過磅應在比賽前一天進行。過磅的時間將由籌委會決定，並於領隊會議公布。正式過磅時間最長為兩 (2) 小時。

2. The random weigh-in will take place at the venue in the morning of the competition. All contestants who pass the general weigh-in must be present for random weigh-in maximum two (2) hours before the start of the competition. Should a contestant fail to appear for the random weigh-in, he/she will be disqualified. The random weigh-in must be completed maximum thirty (30) minutes before the start of the competition each day.

隨機過磅將在當天比賽上午於比賽場地進行。所有通過正式過磅的參賽選手必須在比賽開始最多兩 (2) 小時前出席隨機過磅。如果參賽選手未能出席隨機過磅，他/她將被取消參賽資格。每天比賽開始前三十 (30) 分鐘必須完成隨機過磅。

- 2.1 The rate of selection for the random weigh in shall be determined by the number of contestants in the weight category as following the criteria and subjects will be randomly selected by computerized system maximum two (2) hours before the start of the competition.

隨機過磅的比例由各量級參賽選手人數並依據下列方式最多在比賽開始兩(2)小時前由電腦系統隨機抽出過磅選手。

- a) More than 32 athletes : 20% of total  
超過 32 位選手：抽選 20%
- b) 17-32 athletes : 6 athletes  
17-32 運動員：抽選 6 位
- c) 9-16 athletes : 4 athletes  
9-16 位運動員：抽選 4 位
- d) 4-8 athletes : 2 athletes  
4-8 位運動員：抽選 2 位
- e) Below 4 athletes: None  
少於 4 名選手：不抽選

- 2.2 The random weigh-in shall be conducted with plus 5% tolerance of the contestant's weight category. Underweight shall not be subjected to random weigh-in

隨機過磅為該量級體重上限的 5%。體重不足不受隨機過磅影響

3. During weigh-in, the male contestant shall wear underpants and the female contestant shall wear underpants and a brassiere. However, weigh-in may be conducted in the nude if the contestant wishes to do so.

過磅時，男子選手應穿著底褲，女子選手應穿著胸罩與底褲過磅，若出於選手自願，則可以裸體過磅。

3.1 Cadet and junior contestant must be weighed with underwear(s) and 100 grams will be allowed to compensate.

少年及青少年選手必須著內衣褲過磅並允許增加 100 克重量。

4. General weigh-in shall be made once, however, one more weigh-in is granted within the time limit to any contestant who did not qualify the first time. Random weigh-in shall be made only once per contestant, and there will not be 2<sup>nd</sup> weigh-in.

正式過磅以一次為限，然如果選手於第一次過磅沒有通過，則可以在限定的時間內再過磅一次。隨機過磅只允許一次機會，不會有第二次機會過磅。

5. So as not to be disqualified during the weigh-in, scales identical to the official one shall be provided at the contestants' place of accommodation or at the competition venue for pre-weigh-in.

為了讓選手通過正式的過磅，應於住宿地點或競賽場地提供參賽選手一個與正式過磅使用之同款磅秤，以便於選手先行試秤。

---

(Explantion#1) (解釋#1)

The contestants on the day of competition:

This is defined as those contestants listed to compete on the scheduled day by the Organizing Committee or the WT.

當日參賽的選手:

此定義為籌備會或世界跆拳道聯盟所訂賽程表，所列出選手之出賽日期。

(Explanation #2) (解釋#2)

A separate site for the weigh-in shall be installed for the male and female contestants. The gender of weigh-in officials should be the same as that of the contestants.

男、女選手應有個別的過磅室，並應由與選手相同性別之工作人員負責過磅。

(Explanation #3) (解釋#3)

Disqualification during weigh-in:

When a contestant is disqualified at the weigh-in the contestant shall not be awarded any ranking points.

未通過正式過磅失格:

若選手於正式過磅時不合格，則該選手將無法獲得排名積分。

(Explanation #4) (解釋#4)

Scales, identical to the official one:

The practice scale must be of the same type and calibrations as that of the official scale and these facts must be verified prior to the competition by the Organizing Committee.

與正式過磅使用之同款磅秤:

試磅使用的磅秤與正式過磅使用之磅秤應為同款型號並校準為相同正確的量度規格，籌備會應於賽前驗證確認。

---

## Article 10 Procedure of the Contest 第 10 條 競賽程序

- 1 Call for contestants: The name of the contestants shall be announced at the Athlete Calling Desk three (3) times beginning thirty (30) minutes prior to the scheduled start of the contest. If a contestant fails to report to the Desk following the third call, the contestant shall be disqualified, and this disqualification shall be announced.

播報選手姓名: 選手播報處於競賽開始 30 分鐘前應廣播選手的姓名 3 次。如果參賽者於第三次廣播其姓名後, 仍未能與播報處確認回應, 應取消其競賽資格, 並公告週知。

- 2 Inspection of body, uniform and apparatus: After being called, the contestants shall undergo inspection of body, uniform and apparatus at the designated inspection desk by the inspectors designated by the WT, and the contestant shall not show any signs of aversion, and also shall not wear any materials which may cause harm to the other contestant.

檢查身體、服裝與裝備: 選手被廣播唱名後, 應至檢錄處接受世界跆拳道聯盟所指派的檢錄人員進行身體、服裝與裝備的檢查, 選手不應顯露不當之神情, 更禁止穿戴任何可能造成對手傷害之物件。

3. Entering the Competition Area: After inspection, the contestants shall proceed to the Coach's zone with one coach and one team doctor or team medical staff (such as physiotherapist, athletic trainer or chiropractor, if any).

進入競賽場地: 經檢錄後, 選手連同一位指導教練與一位隊醫或醫護人員進入教練區等待。(物理治療師、運動防護員、整脊師, 如果有的話)

- 4 Procedure before the Beginning and After the End of the Contest

競賽前與競賽後的程序:

- 4.1 Before the start of the contest, the center referee will call "Chung, Hong." Both contestants will enter the Contest Area with their head PSS firmly tucked under their left arms. When any of contestant is not present or present without being fully attired, including all protective equipment, uniform, etc, at the Coach's Zone by the time the referee calls "Chung, Hong", he/she shall be regarded as withdrawn from the contest and the referee shall declare the opponent as the winner.

開始競賽前, 主審會宣告 "Chung(青), Hong(紅)", 雙方選手須將護頭盔至於左手臂內, 然後進入競賽區。若在主審宣告 "Chung(青), Hong(紅)" 時, 選手不在教練指導區域或已在但未徹底完成如護具、道服等裝備之穿戴者, 則以棄權判定, 主審應宣告對手選手為勝方。

- 4.2 The contestants shall face each other and make a standing bow at the referee's command of "Cha-ryeot (attention)" and "Kyeong-rye (bow)". A standing bow shall be made from the natural standing posture of "Cha-ryeot" by bending the waist at an angle of more than 30 degrees with the head inclined to an angle of more than 45 degree. After the bow, the contestants shall put on their head pss.

當主審宣告 "Cha-ryeot (立正)" 與 "Kyeong-rye (敬禮)" 指示時, 選手以立姿鞠躬方式相互行禮。行禮方式應為自然站立姿勢並前彎腰部超過 30 度, 頭部前顎向下超過 45 度以上, 行禮後, 雙方選手應戴上頭盔。

- 4.3 The referee shall start the contest by commanding “Joon-bi (ready)” and “Shi-jak (start)”.  
經主審宣告“Joon-bi(準備)”與“Shi-jak (開始)”指示後開始進行競賽。
- 4.4 The contest in each round shall begin with the declaration of “Shi-jak (start)” by the referee.  
主審應於每回合開始時宣告“Shi-jak (開始)”指令。
- 4.5 The contest in each round shall end with the declaration of “Keu-man (stop)” by the referee。 Even if the referee did not declare “Keu-man”, the contest shall be deemed to have ended when the match clock expired, however, “Gam jeom” can be given and registered in score even after expiration of match clock  
每一回合結束時，應由主審宣告“Keu-man(結束)”指令，當競賽結束時，即使主審未宣告“Keu-man(結束)”，該回合競賽仍應被視為已經結束。然而，即使比賽時間終了，仍可以給予扣分判罰並記錄於計分器中。
- 4.6 The referee may pause a contest by declaring “Kal- yeo” (break) and resume the contest by the command of “Kye- sok” (continue). When the referee declares “Kal- yeo” the recorder should immediately stop the match time; when the referee declares “Kye-sok” the recorder should immediately restart the match time.  
主審可以宣告“Kal- yeo (暫停)”暫停競賽與宣告“Kye- sok (繼續)”恢復競賽。當主審宣告“Kal- yeo”時，記錄人員應立即停止競賽時間，當主審宣告“Kye- sok ”時，記錄人員應立即恢復競賽時間。
- 4.7 After the end of the last round, the referee shall declare the winner by raising his/her hand to the winner’s side.  
當最後一回合結束後，主審應舉起靠近優勝方的手臂宣佈獲勝選手。
- 4.7.1 In the best of three (3) system, the referee shall declare the winner of respective round。  
在三戰二勝制中，主審應於每一回合宣布優勝者

#### 4.8 Retirement of the Contestants

選手退場。

### 5 Contest Procedure in Team Competition

團體競賽的程序

- 5.1 Both teams shall stand facing each other in line in the submitted team order towards the 1<sup>st</sup> Boundary Line from the Contestants’ marks.  
雙方隊伍依照出賽表的順序朝第一邊界線方向整齊排成一列，並相互面對站立。
- 5.2 Procedure before the beginning and after the end of the contest shall be conducted as in clause 4 of this article.  
競賽開始前與競賽結束後的程序應依據本條文第4項規定之內容進行。
- 5.3 Both teams shall leave the Contest Area and stand by at the designated area for each contestant’s match.



雙方隊伍退出競賽區並在各自指定區域裡準備上場競賽。

- 5.4 Both teams shall line up in the Contest Area immediately after the end of the final match facing each other.

當最後一場競賽結束後，雙方隊伍應立即在競賽區內整齊排列並相互面對。

- 5.5 The referee shall declare the winning team by raising his/her own hand to the winning team's side.

主審應舉起靠近優勝隊伍的手臂宣告獲勝隊伍。

---

(Explanation#1) (解釋#1)

Team doctor, chiropractor, athlete trainer or a physiotherapist:

At the time of submission of entry for team officials, copies of relevant and appropriate licenses of team doctor chiropractor, athletic trainer or physiotherapist written in English shall be attached. After verification, special accreditation cards shall be issued to those team doctor, chiropractor, athlete trainer or physiotherapists. Only those who have obtained proper accreditation shall be allowed to proceed to competition area with coach. Only medical doctor with active medical license who graduated from recognized medical school can obtain accreditation card of team doctor. Other medical staff (team chiropractor, athletic trainer, physiotherapist or other healthcare professionals) are not allowed to claim themselves as team doctor, which shall be regarded as improper accreditation.

隊醫、整脊師、運動防護員或物理治療師:

在為團隊官員提交參賽資料時，應附上以英文書寫的隊醫、整脊師、運動防護員或物理治療師的相關和適當的執照副本。經核實後，應向隊醫、運動員防護員或物理治療師發放特殊認可卡。只有獲得適當認證的人才可以和教練一起進入比賽區域。只有從認可的醫學院畢業且具有有效醫療執照的醫生才能獲得隊醫的認證卡。其他醫務人員（整脊師、運動防護員、物理治療師或其他醫療保健專業人員）不得自稱是隊醫，這將被視為不適當的認證。

(Guideline for officiating) (執裁方針)

In the case of using PSS, the referee shall check if the PSS system and sensing socks worn by both athletes are properly working. This process, however, may be deleted to save time for speedy competition management.

在使用 PSS 電子護具的情況下主審應確認電子護具系統與雙方選手之電子感應襪是否正常運作。然而，這個過程可能會被刪除，以便節省時間並加速競賽管理。

## Article 11 Permitted techniques and areas 第 11 條 合法技術與區域

### 1. Permitted techniques

合法技術

1.1 **Fist technique:** A straight punching technique using the knuckle part of a tightly clenched fist

正拳技術: 以緊握拳頭指關節部位正面直擊的技術。

1.2 **Foot technique:** Delivering techniques using any part of the foot below the ankle bone

腳部技術: 以腳踝以下部位達成攻擊的技術。

### 2. Permitted areas

合法攻擊的區域

2.1. **Trunk:** Attack by fist and foot techniques on the areas covered by the trunk protector are permitted. However, such attacks shall not be made on the part of the spine.

軀幹: 以拳、腳技術攻擊護具保護軀幹之部位，為合法攻擊，但嚴禁攻擊脊椎部位。

**Head:** The area above the collar bone. Only foot techniques are permitted.

頭部: 鎖骨上方的區域，僅允許以腳部技術攻擊。

## Article 12 Valid Points 第 12 條 有效得分

### 1 Scoring Areas

得分區域

#### 1.1 Trunk: The blue or red colored area of the trunk protector

軀幹: 軀幹護具青色或紅色部分。

#### 1.2 Head: The entire head above the bottom line of the head protector

頭部: 下顎底線以上頭部的整個頭盔範圍。

### 2 Criteria for valid point(s):

有效得分標準

#### 2.1 Point(s) shall be awarded when a permitted technique is delivered to the scoring areas of the trunk with a proper level of impact.

以合法技術及適當衝擊力度擊中軀幹得分區域，應予以計分。

#### 2.2 Point(s) shall be awarded when a permitted technique is delivered to the scoring areas of the head.

以合法技術擊中頭部得分區域時，應予以計分。

#### 2.3 The determination of the validity of the technique, level of impact, and/or valid contact to the scoring area shall be made by the electronic scoring system except fist techniques. These PSS determinations shall not be subject to Instant Video Replay except for head kicks.

有效技術、衝擊程度和/或與得分區域的有效接觸應由電子計分系統進行，但正拳技術除外。由電子護具計分系統的計分不得提出錄像審議。除了頭部踢擊之外

#### 2.4 The WT Technical Committee shall determine the required level of impact and sensitivity of the PSS, using different scales in consideration of weight category, gender, and age groups. In certain circumstances as deemed necessary the Technical Delegate may recalibrate the valid level of impact.

世界跆拳道聯盟技術委員會應考慮體重級別、性別與年齡層，採用不同的尺度。在某些情況下，如果有必要，技術代表可重新調整衝擊度標準。

### 3 The valid points are as follows .

有效得分如下:

#### 3.1 One (1) point for a valid punch to the trunk protector

1 分: 有效正拳技術擊中軀幹護具。

#### 3.2 Two (2) points for a valid kick to the trunk protector

2 分: 有效踢擊技術擊中軀幹護具

- 3.3 Three (4) points for a valid turning kick to the trunk protector  
4分: 有效轉身踢擊技術擊中軀幹護具。
- 3.4 Three (3) points for a valid kick to the head  
3分: 有效踢擊技術擊中頭部。
- 3.5 Four (5) points for a valid turning kick to the head  
5分: 轉身踢擊技術有效擊中頭部。
- 3.6 One (1) point awarded for or every one Gam-jeom given to the opponent contestant  
由於對手被” Gam-jeom” 判罰而獲得 1 分。
- 4 Match score shall be the sum of points of the three rounds.  
競賽得分計算應為三回合的得分總和。
- 4.1 In the best of three (3) system, match score shall be the sum of the number of round won of the three rounds.  
在三戰二勝制中，競賽得分計算應為三回合中獲勝回合數
- 5 Invalidation of point(s): When a contestant records points following prohibited act(s):  
得分無效: 選手以違規行為後得分:
- 5.1 If prohibited act is followed by point(s), the referee shall declare the penalty for the prohibited act and invalidate the point(s).  
如果以違規行為得分，主審應宣告違規判罰並取消得分。

---

(Explanation#1) (解釋#1)

Back kick (Dwichagi) is one type of turning kick techniques, the head and shoulder rotation must occur to be considered as a back kick (Dwichagi) and awarded technical

後踢技術是轉身技術動作的其中一種，頭部及肩膀必須出現轉動的動作才會被視為後踢並給予技術分數。

When contestants kick opponent by the back kick ( Dwichagi) without contestant’s simultaneous rotation of head and shoulder ‘Back kick’ (Dwichagi) will not be considered turning kick

當選手使用後踢技術（Dwichagi）攻擊對手時，若沒有旋轉頭部及肩膀，”後踢”（Dwichagi）將不被視為轉身踢擊動作。

## Article 13 Scoring and publication 第 13 條 計分與公佈

- 1 Scoring of valid point(s) shall be determined primarily using the electronic scoring system installed in Protector and Scoring Systems (PSS). Points awarded for punching techniques and additional points awarded for turning kicks shall be scored by judges using manual scoring devices. If PSS (Protector & Scoring System) is not used, all scoring shall be determined by judges using manual scoring devices.  
有效得分由電子護具計分系統判定。正拳給分與轉身踢擊技術分，由副審以按分方式計分。如果未使用電子護具計分系統，所有得分皆由副審以按分方式計分。
- 2 If head PSS not employed with trunk PSS, scoring for kicking techniques to the head shall be made by judges using the manual scoring devices.  
如果電子護頭盔沒有與電子軀幹護具一起採用，擊中頭部的有效得分，由副審以按分方式計分。
- 3 The additional point given for a turning kick shall be invalidated if the turning kick was not scored as a valid point(s) by PSS.  
如果轉身踢擊未被電子護具與計分系統(PSS)計分，由副審計入的技術分視為無效。
- 4 Under a three (3) corner judge setting, two or more judges shall be needed to confirm valid scoring.  
在編制三位副審的設置下，有效得分必須是有兩位或兩位以上的副審確認計分。
- 5 Under a two (2) corner judges setting, two judges shall be needed to confirm valid scoring.  
在編制兩位副審的設置下，有效得分必須是有兩位副審確認計分。
- 6 If a referee perceives a contestant to be staggering, a strong impact to the head, kick to the eye(s), bleeding or knocked down by a kick to the head, and so begins counting, but the attack was not scored by the head PSS, the referee or coach must request IVR to make the decision for awarding or not awarding points after the count.  
如果裁判見選手遭踢擊中頭部出現流血或擊倒，並開始讀秒，但此攻擊並未被電子頭盔計分，在讀秒後，主審或教練須提出即時錄像審議確認是否得分。

## Article 14 Prohibited acts and Penalties 第 14 條 違規行為與罰則

- 1 Penalties shall be declared by the referee.  
判罰違規必須經由主審宣告進行。
- 2 Prohibited acts which described in article 14 shall be penalized with Gam-jeon by referee.  
比賽中出現第 14 條所列之違規行為，由主審給予扣分判罰。
- 3 A “Gam-jeom” shall be counted as one (1) additional point for the opposing contestant.  
1 個 “Gam-jeom (扣分)” 應為對方選手加 1 分。
- 4 Prohibited acts.  
違規行為
  - 4.1 The following acts shall be classified as prohibited acts, and “Gam-jeom” shall be declared.  
下列違規行為應宣告扣分判罰 (Gam-jeom) 。
    - 4.1.1 Crossing the Boundary Line  
逾越邊界線
    - 4.1.2 Falling down  
倒地
    - 4.1.3 Avoiding or delaying the match  
規避或拖延競賽
    - 4.1.4 Grabbing or pushing the opponent  
抓、推對手
    - 4.1.5 The following are considered prohibited acts:  
下列行為將被視為違規行為
      - a) Lifting the leg to block  
抬腳阻擋
      - b) Kicking the opponent’s leg to impede the opponent’s kicking attack  
踢擊對手的腳以阻止對手的攻擊
      - c) Kick was aiming to below the waist  
瞄準腰部以下攻擊
      - d) Lifting the leg above waist for kicking in the air for four (4) times or more

腳抬高於腰部以上並在空中踢擊(4)次或以上

- e) Lifting a leg or kicking in the air for more than three (3) seconds to impede opponent's potential attacking movements

抬腳在空中或踢擊超過三秒企圖阻止對手潛在的攻擊

4.1.6 Kicking below the waist

攻擊腰部以下

4.1.7 Attacking the opponent after “Kal-yeo”

宣告“Kal-yeo”後攻擊對手

4.1.8 Hitting the opponent's head with the hand

以手攻擊對手的頭部

4.1.9 Butting or attacking with the knee

以膝蓋衝撞或攻擊對手

4.1.10 Attacking the fallen opponent

攻擊倒地的對手

4.1.11 Attacking trunk PSS with the side or bottom of the foot in clinch position

在近身時，以足內側或足底攻擊對手軀幹。

4.1.12 Attacking back of head PSS in clinch position

在近身時攻擊電子頭盔後面

4.1.13 Following Misconducts of contestant or coach

選手或指導教練行為失當

- a) Not complying with the command or decision

不停聽從裁判指示或判決

- b) Inappropriate protesting behavior to officials' decisions

對裁判判決做出不當的抗議行為

- c) Inappropriate attempts to disturb or influence the outcome of the match

企圖干擾或影響比賽結果

- d) Provoking or insulting the opposing contestant or coach

向對手及教練做出挑釁行為

- e) Unaccredited doctor/physicians or other team officials found to be seated in the doctor's position

非經認證的醫護人員或是其它隊職員坐隊醫席

- f) Any other severe misconduct or unsportsmanlike conduct from a contestant or coach

教練或選手出現嚴重不當行為或違反體育道德行為

- g) When a contestant commits a prohibited Act followed by an Attack After “Kal-yeo”(as per article 14.4.1.7) or any other unsportsmanlike behavior (as per article 14.4.1.13) the Referee may give a 2nd“Gam-jeom”for ‘Attack after “Kal-yeo”’ or ‘Misconduct’.

當參賽者在犯規行為後再做出離開後攻擊行為（根據第 14.4.1.7 條）或任何其他不符合體育道德的行為（根據第 14.4.1.13 條），裁判可以對於“離開後攻擊”或“不當行為”給予第二次“判罰”。

- 4.2 When a coach or contestant commits excessive misconduct and does not follow the referee’s command the referee may declare a sanction request by raising a yellow card. In this case the Competition Supervisory Board shall investigate the contestant’s and/or coach’s behavior and determine whether a sanction is appropriate

當指導教練或選手觸犯過多的違規行為和不遵守主審的指令，主審可舉黃牌請求紀律處分。在此情況下，競賽管理委員會應調查指導教練或選手的行為，並確認處分是否適當。

- 5 If a contestant intentionally and repeatedly refuses to comply with the Competition Rules or the referee’s orders, the referee may end the match raising yellow card and declare the opposing contestant the winner.

如果一個選手故意並多次拒絕遵守競賽規則與裁判的指令，主審可以舉黃牌並終止競賽，宣告其對手獲勝。

- 6 If the referee at the inspection desk or officials in the Field of Play determines, in consultation with the PSS technician, if necessary, that a contestant or coach has attempted to manipulate the sensitivity of PSS sensor(s) and/or inappropriately alter the PSS so as to affect its performance, the contestant shall be disqualified.

如果裁判於檢錄區或競賽場地工作人員確認選手或指導教練企圖操縱電子護具計分系統感應器之靈敏度，或不適當的改變電子護具及計分系統裝備影響其性能，必要時與電子護具及計分系統技術人員諮詢後，將取消資格該選手資格。

- 7 When a contestant receives ten (10) Gam-jeom, the referee shall declare the contestant loser by punitive declaration (PUN).

當選手遭判罰 10 次“Gam-jeom (扣分)”，主審裁判得宣告該名選手扣分敗。判定為”裁判懲處”(PUN)。

- 7.1 In the best of three (3) system, when a contest receives five (5) “Gam jeom” in a round, the opponent will be declared the winner of that round

在三戰二勝制中，如果選手在回合中獲得五(5)次扣分判罰，對手將被宣判獲勝。



8. In Article 14.7 “Gam-jeom” shall be counted in the total score of the three rounds 。 在 14.7 條款中的 “Gam-jeom (扣分)” 應與三回合的總分合計。
- 

(Interpretation) (說明)

Objectives in establishing the prohibited acts and penalties are as follows:

制定違規行為與罰則的目的如下:

- i. To secure the contestant’s safety  
保護參賽選手
- ii. To ensure fair competition  
確保公平競爭
- iii. To encourage appropriate techniques  
鼓勵適當的技術

(Explanation #1) (解釋#1)

Gam-jeom

扣分

- i. Crossing the Boundary Line:  
A “Gam-jeom” shall be declared when one feet of a contestant cross the Boundary Line. No “Gam-jeom” will be declared if a contestant crosses the boundary line as a result of a prohibited act by the opposing contestant  
逾越邊界線:  
當選手單腳踏出邊界線時，主審應給予一個“扣分”判罰(Gam-jeon)。如果因為對手違規而出界者，應給予對手違規判罰。
- ii. Falling down:  
‘Gam-jeom’ shall be declared for falling down 。 However , if a contestant falls down due to the opponent’s prohibited acts; ‘Gam-jeom’ penalty shall not be given to the fallen contestant , while a penalty shall be given to the opponent 。 If both contestants fall as a result of incidental collision, or in case a contestant who received a point with turning kick falls down , no penalty shall be given 。  
倒地:  
當選手倒地的情況下，應給予 “扣分”判罰(Gam-jeon)”。然而，如果選手因對手違規而跌倒，不應判罰倒地者，而應判罰對手。如果雙方選手因意外碰撞而跌倒，或是轉身踢擊得分後倒地，則不需給予判罰。
- iii. Avoiding or delaying the match:  
逃避或拖延比賽
  - a) This act involves stalling with no intention of attacking. A contestant who continuously displays a non-engaging style shall be given a “Gam-jeom”. If both contestants remain inactive after three (3) seconds, the center referee will signal the “Gong-gyeok” command. A “Gam-jeom” will be declared: On both contestants if there is no activity from them 3 seconds after the command was given; or on the contestant who moved backwards from

the original position 3 seconds after the command was given.

這種行為涉及無意願攻擊的拖延。當一個選手持續顯示低進攻意願，應給予”扣分”判罰(Gam-jeon)。雙方選手於 3 秒內皆無攻擊動作時，主審將下達“Gong-gyeok”(攻擊)”指令。3 秒仍無攻擊動作或其中一方由原先的位置向後退卻，應給予“扣分”判罰(Gam-jeon)。

- b) Turning the back and move away to avoid the opponent’s attack should be punished as it expresses the lack of a spirit of fair play and may cause serious injury. The same penalty should also be given for evading the opponent’s attack by bending below waist level or crouching.

轉身避開對手攻擊被視為缺乏公平競爭的精神，並可能造成嚴重傷害應予以判罰。此外，彎腰低於腰部以下或蹲下躲避對手攻擊也應予以判罰。

- c) Retreating from the technical engagement only to avoid the opponent’s attack and to run out the clock, “Gam-jeom” shall be given to the passive contestant.

消極的技術性後退只為了避免對手進攻並耗盡時間，應給予被動選手“扣分”判罰

- d) Pretending injury means exaggerating injury or indicating pain in a body part not subjected to a blow for the purpose of demonstrating the opponent’s actions as a violation, and also exaggerating pain for the purpose of elapsing the match time. In this case, the referee shall give a “Gam-jeom” however referee may request IVR for clarification before declaration of “Gam-jeom” for pretending injury

偽裝受傷是指誇大傷害或刻意指示身體疼痛部位以表明對手違規，抑或是誇大所受之傷害以拖延競賽時間，於此情況下，主審應給予該選手應給予“扣分”判罰。然而，裁判可以在宣佈「Gam-jeom」前要求 IVR，確認是否假裝受傷。

- e) “Gam-jeom” shall also be given to the athlete who asks the referee to stop the contest in order to adjust the position/fit of protective equipment.

當選手要求暫停競賽，以調整其防護裝備，主審也應給予”扣分”判罰。

iv. Grabbing, pushing the opponent:

抓、推對手:

- a) This includes grabbing any part of the opponent’s body, uniform or protective equipment with the hands. It also includes the act of grabbing the foot or leg or hooking the leg with forearm. For pushing, the following acts shall be penalized.

這包括用手抓住對手身體的任何部分、道服或護具器材。此外，包括抓腳或腿或勾前臂的行為。下列推之行為，應予判罰

- pushing the opponent with prolonged or continuous contact  
長時間或連續碰觸推對手
- pushing the opponent out of the boundary Line ,  
將對手推出界。
- pushing the opponent in a way that prevents kicking motion or any normal execution of attacking movement  
以推的方式阻礙對手的攻擊動作或干擾其任何正常技術的執行。

- v. Lifting the leg or cut kick motion shall not be penalized only when it is followed by execution of punching or kicking technique in combination motion

抬腿或是牽制動作後並立即接續正拳或是踢擊攻擊動作，不應給予判罰

- vi. Attacking below the waist:

攻擊腰部以下:

This action applies to an attack on any part below the waist. When an attack below the waist is caused by the recipient in the course of an exchange of techniques, no penalty will be given. This article also applies to strong kicking or stamping actions to any part of the thigh, knee or shin for the purpose of interfering with the opponent's technique.

此條款適用於攻擊腰部以下的任何部位，如果攻擊腰部以下是因為受攻擊者在變換技術的過程所造成，則不予判罰。本條文也適用於為達到干擾對手技術的目的，以強力踢擊或蹬踩對手大腿、膝蓋或小腿任何部分的動作行為。

- vii. Attacking the opponent after “Kal-yeo”:

宣告 “Kal-yeo (離開)” 後攻擊對手:

- a) Attacking after Kal-yeo requires that the attack results in actual contact to the opponent's body.

宣告 “Kal-yeo(離開)” 後的攻擊導致實際接觸到對手的身體。

- b) If the attacking motion started before the Kal-yeo, the attack shall not be penalized.

如果攻擊動作始於宣告 “Kal-yeo(離開)” 前，則不予判罰。

- c) In Instant Video Replay, the timing of Kal- yeo shall be defined as the moment that the referee's Kal-yeo hand signal was completed (with fully extended arm); and the start the attack shall be defined as the moment that the attacking foot is fully off the floor.

錄像審議的時序裡，“Kal-yeo(離開)” 定義為主審完成 “Kal-yeo(離開)” 手勢(完全伸展手臂)的那一時刻；而開始攻擊應被定義為攻擊的腳完全離開地面的時刻

- d) If an attack after Kal-yeo did not land on the opponent's body but appeared deliberate and malicious the referee may penalized the behavior with a ‘Gam-jeom’ .

如果宣告 “Kal-yeo(離開)” 後的攻擊動作沒有接觸到對手的身體，但表現出故意和惡意行為，主審可以給予 “扣分” 判罰(Gam-jeon)”

- viii. Hitting the opponent's head with the hand:

以手攻擊對手的頭部:

This article includes hitting the opponent's head with the hand (fist), wrist, arm, or elbow. However, unavoidable actions due to the opponent's carelessness such as excessively lowering the head or carelessly turning the body cannot be punished by this article.

此條款適用於以手(拳頭)、手腕、手臂或手肘擊打對手的臉部。然而，若導因於不可避免之因素，因對手疏忽所造成不可避免的動作，例如，過度降低頭部或無心的轉身，則不適用此條款。

- ix. Butting or attacking with the knee:

以膝蓋攻擊或衝撞對手:

This article relates to an intentional butting or attacking with the knee when in close proximity to the opponent. However, contact with the knee that happens in the following situations cannot be punished by this article.

本條款適用於雙方選手於近身時故意以膝蓋衝撞阻擋或攻擊對手然而，若膝蓋攻擊的動作發生於下列狀況，則不得以此條款判罰。

- When the opponent rushes in abruptly at the moment a kick is being executed  
當正在執行踢擊技術時，對手向前衝進來
- Inadvertently, or as the result of a discrepancy in distance in attacking.  
因距離誤差無意間所造成的

x. **Attacking the fallen opponent:**

攻擊倒地的對手:

This action is extremely dangerous due to the high probability of injury to the opponent. The danger arises from the following:

這是造成對手嚴重傷害機率非常高的危險動作。其危險因素如下:

- The fallen opponent is in an immediate defenseless state  
對手倒地的瞬間處於無防禦狀態。
- The impact of any technique which strikes a fallen contestant will be greater due to the contestant's position. These types of aggressive actions toward a fallen opponent are not in accordance with the spirit of taekwondo and as such are not appropriate to taekwondo competition. In this regard, penalties should be given for intentionally attacking the fallen opponent regardless of the degree of impact

就雙方選手的關係位置，任何技術將對於倒地選手造成更大的撞擊，這類朝向倒地對手的侵略行為不符合跆拳道精神，不適合存在於跆拳道競賽中。基於此點，無論倒地對手受到蓄意攻擊影響的程度如何，都應予以判罰。

When misconduct is committed by a contestant or a coach during a rest period, past the five (5) seconds of the round conclusion, the referee can immediately declare the "Gam-jeom" and the "Gam-jeom" shall be recorded to the upcoming round. However, "Gam-jeom" shall be recorded to the previous round if the action happened within five (5) seconds of the round conclusion.

當參賽者或教練在休息期間犯下不當行為時，在回合結束的五（5）秒後，裁判可以立即宣佈“Gam-jeom”，並且“Gam-jeom”應記錄到下一回合。但是，如果動作發生在回合結束后的五（5）秒內，則“Gam-jeom”應記錄到該回合

## Article 15 Golden Point and Decision of Superiority 第 15 條 黃金得分與優勢判定

- 1 In the event the winner cannot be decided after 3 rounds, a 4<sup>th</sup> round (golden round) will be conducted in one-minute round.

在第三回合結束後無法決定出優勝者，將進行第四回合一分鐘的比賽(黃金回合賽)。

- 2 In case of a contest advances to a golden round, all scores awarded during the first three (3) rounds shall be void.

在競賽進行黃金回合賽的情況下，其前三回合獲得的所有分數不列入計算。

- 3 The first contestant scores two (2) or more points or whose opponent receives two “Gam-jeoms” in the golden round shall be declared the winner.

在黃金得分賽回合，先得 2 分的選手或是其對手遭判罰了二個 Gam-jeom(扣分)”者為優勝者。

- 4 In the event that neither contestant has scored two (2) points after the completion of the golden round, the winner shall be decided by superiority based the following criteria

如果在第四回合結束後，雙方選手均無得 2 分的情況下，優勝者將透過以下標準的進行優勢判定：

- 4.1 The contestant who received a point by a punch in the golden round

在黃金回合中以正拳得 1 分的選手

- 4.2 If none of the contestant received a point by a punch or both contestants received a point by a punch each in the golden round, the contestant who achieved a higher number of hits registered by the PSS during the golden round

如果選手中沒有人以正拳得分，或者兩個參賽者在黃金回合中各得一分，則以第四回合裡，電子計分系統紀錄之點擊次數較高者為優勝者

- 4.3 If number of hits registered by the PSS is tied, the contestant who won more rounds in first three rounds

如電子護具計分系統紀錄之點擊次數相同，以前三回合獲勝回合數較多者為優勝者。

- 4.4 If number of round won is tied, the contestant who received less numbers of a Gam-jeom during all four rounds

如前三回合獲勝回合數相同，則以在所有四回合裡，被判罰“扣分 (Gam-jeom)”次數較少者為優勝者。

- 4.5 If the three above criteria are the same, the referee and judges shall determine superiority based on the content of the golden round If the superiority decision is tied among the referee and judges, the referee shall decide the winner.

如果上述三項標準都是相同的，主審與副審應依據第四回合的競賽內容做出優勢判定。如果主審與副審之間之優勢判定的結果雙方相同，由主審決定優勝者。

5. In the best of three (3) system, in case of tie score for corresponding round, the round winner shall be decided by superiority based on following criteria:

在三戰二勝制中如果該回合結束後雙方平手，該回合優勢判定將依據下列條件決定之：

5.1 Most points scored by turning or spinning kick. ◦

轉身或旋轉動作得分較多者獲勝

5.2 If the technical score is the same, the contestant who has more scored in the order of a higher value techniques as follows (Head, Trunk, Punch, Gam Jeom).

如果技術分數相同，則較高技術得分較多者獲勝，技術難度順序排列如下（頭部，軀幹，正拳，扣分）。

5.3 If the high value points are same, the contestant who received higher number of hits registered by the PSS.

如果較高技術得分相同，則以獲得 PSS 踢擊點數較多者獲勝。

5.4 If the three above criteria are the same, the referee and judges shall determine superiority  
如上述條件均相同，主審及副審應依據競賽內容做出優勢判定

a) In case of two (2) corner judges, winner shall be decided by referee and two (2) judges

如果使用兩位（2）副審，獲勝者應由主審和兩（2）名副審決定

b) In case of three (3) corner judges, winner shall be decided by three (3) judges except referee.

如果使用三位（3）副審，除了主審之外，獲勝者由三（3）名副審決定。

---

(Explanation #1) (解釋#1)

Decision of superiority by judges shall be based on technical dominance of an opponent through aggressive match management, the greater number of techniques executed, the use of the more advanced techniques both in difficulty and complexity, and display of the better competition manner.

優勢判定由副審依據選手積極比賽企圖心，展現多元的技術，困難度與複雜度較高的進階技術，及表現更好的比賽方式判定。

(Explanation #2) (解釋#2)

In the event that referee is counting for delivering successful head kick which caused knock down right before the opponent's body kick but only the latest body kick was registered, the coach of the athlete who delivered head kick may request for video replay. If review jury determines that head kick was valid and performed earlier than body kick, the referee shall invalidate the point(s) scored by body kick, then declare points for head kick, and declare the one who delivered head kick as winner

如果裁判在對方身體踢之前成功頭部攻擊導致擊倒並開始讀秒，但只註冊了最新軀幹擊中的分數，則以頭部攻擊的運動員其教練可要求錄像審議。如果陪審確定頭部攻擊執行早於軀幹踢擊，裁判應取消軀幹踢擊得分，然後宣佈頭部攻擊得分，並宣佈頭部攻擊者為優勝者。

In the event that one athlete who already has one (1) point is delivering successful punch right before the opponent's body kick but only the latest body kick was registered, the coach of the athlete who delivered punch may request for video replay. If review jury determines that punch was performed earlier than body

kick, the referee shall ask whether corner judges were scored or not. If two or more corner judges scored for punch, referee shall invalidate the point(s) scored by body kick, then declare points for punch, and declare the one who delivered punch as winner

如果一位選手已獲得一分，並在對手的身體踢之前成功以正拳攻擊，但只有最新的軀幹攻擊被註冊，則正拳攻擊選手的教練可以請求錄像審議。如果陪審確定正拳攻擊早於軀幹攻擊，主審應詢問副審是否得分。如果兩名或兩名以上副審給予正拳得分，裁判應取消軀幹攻擊得分，然後宣佈正拳得分，並宣布正拳攻擊者為優勝者。

(Guideline for officiating) (執裁方針)

The procedure for superiority decision shall be as follows except for the best of three (3) system

除了 3 戰 2 勝制外，優勢判定的程序如下：

- 1) Prior to the contest, all refereeing officials take the superiority card with them.  
競賽開始前，所有的裁判人員都必須隨身攜帶優勢記分卡。
- 2) When a match is to be decided by superiority, the referee shall declare “Woo-se-girok (Record Superiority)”.  
當競賽進行優勢判定時，主審應宣告 “Woo-se-girok (優勢判定)”。
- 3) Upon the referee’s declaration, the judges shall record the winner within 10 seconds with their heads down, sign on the card and then give it to the referee.  
主審宣告 “Woo-se-girok (優勢判定)” 之後，副審應於 10 秒內在優勢計分卡上記下優勝者並簽名，再送交給主審裁判。
- 4) The referee shall collect all superiority cards, record the final result, and then declare the winner.  
主審應收齊優勢記分卡並記錄最後結果，然後宣告優勝者。
- 5) Upon declaration of winner, the referee shall hand over the cards to the recorder and the recorder shall submit the cards to the Technical Delegate of World Taekwondo.  
在宣告優勝者之後，主審應將優勢記分卡送交記錄人員繳交於世界跆拳道聯盟的技術代表。

(Guideline for officiating for the best of three (3) system) 3 戰 2 勝制執裁方針

- 1) When a round is to be decided by superiority, the referee shall declare “Woo se girok (Record Superiority)”.  
當回合結束必須判定優勢判決時，主審應宣告 “Woo se girok”
- 2) Upon the referee’s declaration, the judges declare the winner simultaneously after the Referee’s count of three (3) by using round winner hand signal facing the head table.  
在裁判宣佈後，裁判在裁判讀秒到三（3）後，用面向紀錄台以手勢宣布該回合獲勝者
- 3) In case of two (2) corner judges, winner shall be decided by referee and two (2) corner judges.  
使用兩位副審時，由主審及兩位副審決定優勝者
- 4) In case of three (3) corner judges, winner shall be decided by three (3) corner judges except referee.  
使用三位副審時，主審除外，由三位副審決定優勝者。

- 5) The Review Jury shall record the final result, and declare to Operator the round winner.  
陪審需記錄最終結果，並向電腦操作員宣告該回合優勝者
- 6) Upon declaration of winner, the referee shall declare the round or match winner.  
當優勝者產生後，主審需宣告該回合或該場次優勝者。



## Article 16 Decisions 第 16 條 裁決

- 1 Win by Referee Stops Contest (RSC)  
主審停賽勝 (RSC)
- 2 Win by final score (PTF)  
最終得分勝(PTF)
- 3 Win by point gap (PTG)  
得分差距勝(PTG)
- 4 Win by Golden Point (GDP)  
黃金得分勝(GDP)
- 5 Win by Superiority (SUP)  
優勢判決勝(SUP)
- 6 Win by withdrawal (WDR)  
對手棄權勝(WDR)
- 7 Win by disqualification (DSQ)  
對手失格勝(DSQ)
- 8 Win by referee's punitive declaration (PUN)  
主審裁定懲處勝(PUN)
- 9 Win by disqualification for unsportsmanlike behavior (DQB)  
對手缺乏運動家精神失格勝

---

(Explanation #1) (解釋#1)

Referee Stops Contest:

主審停賽:

The referee declares RSC in the following situations:

主審停賽(RSC)的情況如下:

- i. If a contestant has been knocked down by an opponent's legitimate technique and cannot resume the contest by the count of "Yeo-dul"; or if the referee determines the contestant is not able to resume the competition regardless of the progress of counting;

如果選手遭對手以合法技術擊倒，在主審讀秒至“Yeo-dul(八)”時無法重新復賽；或是主審進行讀秒時認定選手無法繼續比賽。

- ii. If a contestant disregards the referee's command to continue the match three times;  
如果選手無視主審繼續比賽的指令三次。
- iii. If the referee recognizes the need to stop the match to protect a contestant's safety;  
如果主審意識到為確保參賽選手的安全有必要停止競賽。
- iv. when the Commission Doctor determines that the match should be stopped due to a contestant's injury;  
當委任醫生認定選手因受傷得停止該場競賽。

(Explanation #2) (解釋#2)

Win by point gap: In case of twenty (20) points difference between two athletes at the time of the completion of 2<sup>nd</sup> round and/or at any time during the 3<sup>rd</sup> round, the referee shall stop the contest and shall declare the winner by point gap. Win by point gap shall not be applied in semi- finals & finals in senior division by the outline of tournament

得分差距勝(PTG):如遇雙方選手在完成第二回合或第三回合的任何時間，比分差距達 20 分，主審應停止競賽，並宣告裁定領先者得分差距勝。依據競賽規程成人組比賽在半決賽及決賽則不適用。

(Explanation #3) (解釋#3)

Win by withdrawal: The winner is determined by withdrawal of the opponent。

對手棄權勝(WDR): 優勝者因對手棄權而獲勝。

- When a contestant withdraws from the match due to injury or other reasons  
競賽選手因受傷或其他原因棄權
- When the coach throws a towel into the court to signify forfeiture of the match  
指導教練拋出一條毛巾入競賽區內表示放棄競賽

(Explanation #4) (解釋#4)

Win by disqualification: This is the result determined by the contestant's failure in weigh-in or when a contestant fails to report to the Athlete Calling Desk following the third call.

對手失格勝(DSQ): 這是指當選手過磅不合格或是選手於第三次呼叫後未向播報處報到

The follow-up actions should be different in accordance with the reason of disqualification。失格的原因得依據不同的狀況執行後續程序:

- i. In the event that contestants have not passed or did not show at weigh-in: The result should be reflected on the draw sheet and the information should be provided to technical officials and all relevant persons。Referees will not be assigned for this match. The opponent of athletes that did not pass or show at weigh-in will not need to appear at the court to compete  
選手未通過或未參加過磅: 這個結果應公佈於賽程表上，相關資料應提供給技術委員與所有相關人員。這場比賽將不指派裁判執法。未通過或未參加過磅者之對手不需要於此場競賽出場。
- ii. In the event that a contestant passed weigh-in but did not appear at the Athletes Calling Desk: The assigned referee and opponent shall enter the FOP and waiting in their position until the referee declares the opponent a winner of the match. Detailed procedure is stipulated in 4.1 of Article 10  
過磅通過但選手未出現於選手播報處: 裁判人員與對方選手應進入比賽場地並在其位置等待，直

至主審宣告對方選手獲勝。詳細程序規定於競賽規則第 10 條第 4.1 項。

(Explanation #5) (解釋#5)

Win by the referee's punitive declarations:

主審裁定懲處勝(PUN):

The referee declares PUN in the following situations:

主審裁定懲處勝(PUN)的情況如下:

- i. If a contestant accumulated ten (10) “Gam-jeom”;  
選手累積 10 個“扣分 (Gam-jeom)”。

(Explanation #6) (解釋#6)

Win by disqualification for unsportsmanlike behavior: DQB shall be declared in the following situations:

非運動行為取消資格而獲勝:DQB 應在下列情況下聲明:

- When a contestant or any of his/her team member is found manipulating of the sensor(s) or scoring system of the PSS  
當發現參賽者或其任何團隊成員操縱 PSS 的感應器或評分系統時
- When a contestant cheats the process of weigh-in  
當參賽者在過磅過程中作弊
- When a contestant is found violating the WT Anti-Doping Rules  
當參賽者被發現違反 WT 反興奮劑規則時
- When a contestant or coach commits serious infringing behavior described in article 23.3.1& 23.3.2  
當參賽者或教練提出第 23.3.1 條和第 23.3.2 條所述的嚴重侵權行為時

The all result of contestant who lost by DQB shall be removed, and other contestant's result which affected by DQB shall be reallocated

當參賽者是因為 DQB 落敗時，其所有結果將被移除，其他受 DQB 影響的參賽者成績應重新分配

(Explanation #7) (解釋#7)

In the best of three (3) system, the decisions shall follow the procedure of Article 16;

在三戰二勝制中，判決應根據下列程序

- 16.1 Win by Referee Stops Contest (RSC)  
主審停賽勝(RSC)
- 16.2 Win by Final Score (PTF)  
最終得分勝(PTF)
- 16.6 Win by Withdrawal (WDR)  
對手棄權勝(WDR)
- 16.7 Win by Disqualification (DSQ)  
對手失格勝(DSQ)

- 16.9 Win by Disqualification for unsportsmanlike behavior (DQB)

對手缺乏運動家精神失格勝

- i) In case of Article 16.2. Win by final score (PTF), match score shall be the sum of the number of round won of the three rounds.

就第 16 條第 2 款而言。以最終得分獲勝（PTF），比賽比分應為三回合獲勝回合數的總和

- ii) In case of Article 16.3. Win by point (PTG), in case of twelve (12) points difference between two athletes per round, the referee shall stop the contest and shall declare the winner by point gap for corresponding round. Point gap for corresponding round shall not be applied in semi finals & finals in senior division by the outline of tournament.

就第 16 條第 3 款而言，如果在每回合兩名選手之間有十二（12）分差距，裁判應停止比賽並宣告比賽差分勝（PTG），並宣布該回合的獲勝者。根據競賽規程，差分制不適用於成人組的半決賽和決賽。

## Article 17 Knock Down 第 17 條 擊倒

A Knock Down shall be declared when a legitimate attack is delivered and;

當合法攻擊造成擊倒時應當被宣告以及；

- 1 When any part of the body other than the sole of the foot touches the floor due to the force of the opponent's scoring technique  
由於受到對手得分技術重擊力道的影響，致使身體除腳底以外的任何部分接觸到地面。
- 2 When a contestant is staggered and shows no intention or ability to continue as a result of the opponent's scoring techniques。  
由於對手得分技術導致選手蹣跚搖晃失去能力無法繼續比賽。
- 3 When the referee judges that the contest cannot continue as the result of being struck by a legitimate scoring technique  
當主審判定競賽無法繼續為遭受到合法技術擊中的結果。

---

(Explanation #1) (解釋#1)

A knock down:

This is the situation in which a contestant is knocked to the floor or is staggered or unable to respond adequately to the requirements of the match due to a blow。 Even in the absence of these indications， the referee may interpret as a knock down， the situation where， as the result of contact， it would be dangerous to continue or when there is any question about the safety of a contestant

擊倒:

這是因選手遭對手重擊倒地或是身體搖晃且意識不清，致使無法繼續比賽。即使沒有這些跡象，但因為衝撞的結果，若繼續進行競賽將危及選手安全，主審可決定判定擊倒。

---

## Article 18 Procedure in the event of a Knock Down 第 18 條 擊倒事件處理程序

- 1 When a contestant is knocked down as the result of the opponent's legitimate attack, the referee shall take the following measures.

當選手遭對手以合法攻擊擊倒時，主審的處理程序如下：

- 1.1 The referee shall keep the attacker away from downed contestant by declaration of “Kal-yeo (break)”. The recorder shall stop the match clock following the referee's “Kal-yeo (break)” command

主審應宣告“Kal-yeo (離開)”將攻擊者與倒地者分開。當主審宣告“Kal-yeo (離開)”紀錄員應將時間暫停。

- 1.2 The referee shall first check the status of the downed contestant and count aloud from “Ha-nah (one)” up to “Yeol (ten)” at one second intervals towards the downed contestant, making hand signals indicating the passage of time.

主審應先確認倒地選手狀況，然後開始大聲讀秒由“Ha-nah (一)”數到“Yeol (十)”，每個數字間隔一秒鐘，並同時以手勢表示已經過的時間。

- 1.3 In case the downed contestant stands up during the referee's count and desires to continue the fight, the referee shall continue the count up to “Yeo-dul (eight)” for recovery of the contestant. The referee shall then determine if the contestant is recovered and, if so, continue the contest by declaration of “Kye-sok (continue)”.

若選手於主審讀秒時站起來表達復賽意願，主審應繼續讀秒至“Yeo-dul (八)”，讓倒地的選手恢復意識。接下來主審應確認該選手是否已恢復意識，如果是的話，應宣告“Kye sok (繼續)”恢復比賽。

- 1.4 When a contestant who has been knocked down cannot demonstrate the will to resume the contest by the count of “Yeo-dul (eight)”, the referee shall announce the other contestant winner by RSC (Referee Stops Contest).

當被擊倒的選手在讀秒至“Yeo-dul (八)”時，仍無法表達繼續比賽的意願，主審宣告對方選手以主審停賽勝(RSC)獲勝。

- 1.5 In case both contestants are knocked down, the referee shall continue counting as long as one of the contestants has not sufficiently recovered.

如果雙方選手都被擊倒，只要一方未恢復，主審仍需持續讀秒。

- 1.6 In case both contestants are knocked down and both contestants fail to recover by the count of “Yeol”, the winner shall be decided by the match score before the occurrence of Knock Down.

如果讀秒到“Yeol (十)”時，若雙方選手皆無法恢復，優勝者的產生由擊倒前的比分來決定。

- 1.7 When it is judged by the referee that a contestant is unable to continue, the referee may decide the winner either without counting or during the counting.

當主審判定選手已無法繼續出賽，可以不讀秒或在讀秒過程中裁定優勝者。

- 2 Procedures to be followed after the contest: Any contestant who could not continue the match as a result of a serious injury regardless of any parts of the body cannot enter competition within thirty (30) days without approval of the WT Medical Chairman after submission of a statement from the physician designated by the pertinent national federation

賽後程序: 選手無論是因身體上任何部位受傷無法再繼續比賽，於三十天內不得參加任何競賽，在參加新的競賽之前，選手須經該國家協會指定的醫師出具體檢證明擔保後，始得以再度參賽。

- 2.1 Except for medical emergency, any contestant with any serious injury must be evaluated by venue medical doctor and confirmed by medical chairman (MC) at medical room immediately after the contest.

除醫療緊急情況外，任何嚴重受傷的參賽者都必須經過現場委任醫生的評估，並在比賽結束後立即在醫療室接受醫療主席(MC)的確認。

- 2.2 Any contestant who had knockout due to head injury must be checked by medical doctor at medical room per WT medical rules. A venue medical doctor must perform SCAT5 on the injured contestant for diagnosis of concussion in case of head injury within 30minutes after the head injury.

任何因頭部受傷而擊倒的選手，必須按照 WT 醫療規則在醫療室接受醫生檢查。現場醫生必須在頭部受傷後 30 分鐘內對受傷參賽者進行 SCAT5 腦震盪診斷，以防頭部傷害發生

- 2.3 Any significant (moderate to severe) head trauma or concussion carries mandatory suspension for any competition during the suspension period (see 18.2.5) This mandatory medical suspension period cannot be shortened in any circumstances once the suspension is given.

任何嚴重(中度至重度)頭部創傷或腦震盪在暫停期間任何比賽均強制停止(見 18.2.5)一旦暫停，在任何情況下都不能縮短該強制性醫療暫停期。

- 2.4 The decision on the suspension of the contestant for significant head trauma or concussion must be made based the on one of the following criteria (1)~(3).

參賽者因嚴重頭部創傷或腦震盪而被停賽的決定必須根據以下標準之一(1)~(3)做出。

- (1) Comprehensive neurological examination and neurocognitive testing (SCAT 5 or other validated concussion-assessment tools permitted by MC Chair) performed by commissioned doctor in the venue medical room which must be reported to MC Chair

由受大會醫生在競賽場地的醫療事務運動員進行的全面神經學檢查和神經認知測試 (SCAT 5 或醫療委員會主席允許的其他經過驗證的腦震盪評估工具)，並向醫療委員會主席報告

- (2) Referee stop contest due to any loss of consciousness, altered mental status or inability to make a meaningful, stable and voluntary movement as a result of a direct head trauma at least for ten (10) seconds or by the count ten (10)

裁判停止比賽是因為意識喪失，精神狀態改變或由於直接頭部創傷至少十(10)秒或讀至十(10)秒而無法進行有意義，穩定和自願的運動

- (3) Failure to fully recover from head trauma and resume the match within one (1) minute of medical evaluation on the mat after centre referee calls a doctor for possible concussion.

主審因可能的腦震盪而呼叫醫生，在墊子上進行醫學評估後，未能從頭部創傷後一（1）分鐘內恢復比賽。

- 2.5 Any contestant who had diagnosis of significant head trauma or concussion based on one of the above 2.4 criteria will get 30days suspension (senior), 40days suspension (junior) or 50days suspension (cadet). This mandatory medical suspension period cannot be shortened in any circumstances once the suspension is given.

任何根據上述 2.4 標準之一，被診斷為嚴重頭部創傷或腦震盪的參賽者將被強制 30 天停賽（成人），40 天停賽（青少年）或 50 天停賽（少年）。一旦停賽，這種強制性的醫療暫停期在任何情況下都不能縮短。

- 2.6 Any contestant who had second concussion in last 90 days will get 90days suspension and who had third concussion in last 180days will get 180days suspension

任何運動員在過去 90 天內發生過第二次腦震盪將被停賽 90 天，而在過去 180 天內發生第三次腦震盪的運動員將被停賽 180 天。

- 2.7 For any incidence of concussion or significant head trauma underreported, misdiagnosed or mismanaged without mandatory medical suspension, WT Sport Department and WT MC Medical Committee led by WT MC Chair shall start investigating the incidence by retrospective video review even after the end of the competition. The incidence must be reported to WT MC Chair within 30days after the incidence date to commence the investigation. If the video review confirmed by at least three (3) reviewers of WT medical committee reveals obvious concussion or serious head trauma (knockout more than 10 seconds) or other serious injuries which mandate at least 30 day mandatory medical suspension, WT medical committee shall override the medical examiner (OMD or commissioned doctor)'s decision and apply the mandatory suspension rules to the athlete to protect the health and safety of the contestant.

對於任何腦震盪或嚴重頭部的創傷，在沒有強制停賽的情況下被低估，誤診或處理不善，WT 競賽部和 WT 醫療委員會由 WT 醫療委員會主席領導，即使在比賽結束後，也應開始透過回顧性錄像審查來調查。必須在發生日後 30 天內向 WT 醫療委員會主席報告並開始調查。如果 WT 醫療委員會有至少三(3)名委員確認的錄像審查顯示明顯腦震盪或嚴重頭部創傷(擊倒後超過 10 秒)或其他嚴重傷害，要求至少 30 天強制停賽，WT 醫療委員會應推翻醫生(現場醫生或委任醫生)的決定，並對運動員實施強制性停賽規則，以保護運動員的健康和安全。

---

(Explanation #1) (解釋#1)

Keep the attacker away:  
分開攻擊者

In this situation the standing opponent shall return to the respective contestant's mark, however, if the downed contestant is on or near the opponent's contestant's mark, the opponent shall wait at the boundary line in front of his/her coach's chair.

於此情況下，站著的對手應回到場中屬於己方的定位，但若是倒地的選手是在對手的選手定位或靠近於其附近，對手應在其指導教練位置前的邊界線等候。



(Guideline for officiating) (執裁方針)

The referee must be constantly prepared for the sudden occurrence of a knock down or situation where the contestant is staggered, which is usually characterized by a powerful blow accompanied by impact.

主審應隨時因應於擊倒突發情況造成選手蹣跚不穩，其特徵通常是一個強力擊打後伴隨著的特徵。

(Explanation #2) (解釋#2)

In case the downed contestant stands up during the referee's count and desires to continue the fight:

The primary purpose of counting is to protect the contestant. Even if the contestant desires to continue the match before the count of eight is reached, the referee must count until "Yeo-dul (eight)" before resuming the match. Counting to "Yeo-dul" is compulsory and cannot be altered by the referee

若選手於主審讀秒時站起來表達復賽意願：

讀秒的目的是為了保護選手。在讀秒至“Yeo-dul (八)”以前，即使選手表達復賽意願，主審仍須於復賽前讀秒至“Yeo-dul (八)”。讀秒至“Yeo-dul (八)”是強制性的，主審不得變更。

\*Count from one to ten: Ha-nah, Duhl, Seht, Neht, Da-seot, Yeo-seot, Il-gop, Yeo-dul, A-hop, Yeol.

讀秒由“1”讀到“10”：Ha-nah, Duhl, Seht, Neht, Da-seot, Yeo-seot, Il-gop, Yeo-dul, A-hop, Yeol.

(Explanation #3) (解釋#3)

The referee shall then determine if the contestant has recovered and, if so, restart the contest by the declaration of "Kye-sok": The referee must ascertain the ability of the contestant to continue while he/she counts until eight. Final confirmation of the contestant's condition after the count of eight is only procedural and the referee must not needlessly pass time before resuming the contest.

主審應確認選手是否已恢復意識，如果是的話，應宣告“Kye-sok (繼續)”恢復競賽：裁判必須讀秒至八時確定參賽者繼續比賽的能力。在讀至八時，對參賽者狀態的最終確認只是必要的程序，裁判在恢復比賽之前不應花費太多時間。

(Explanation #4) (解釋#4)

When a contestant who has been knocked down cannot express the will to resume by the count of "Yeo-dul", the referee shall announce the other contestant winner by RSC. after counting to "Yeol":

The contestant expresses the will to continue the match by gesturing several times in a fighting position with the clenched fists. If the contestant cannot display this gesture by the count of "Yeo-dul", the referee must declare the other contestant winner after first counting "A-hop" and "Yeol". Expressing the will to continue after the count of "Yeo-dul" cannot be considered valid. Even if the contestant expresses the will to resume by the count of "Yeo-dul", the referee can continue counting and may declare the contest over if he/she determines the contestant is incapable of resuming the match.

當被擊倒的選手在讀秒到“Yeo-dul (八)”以前仍無法表示出繼續比賽的意願，主審繼續讀秒至 10 秒後宣告對方選手以主審停賽勝(RSC)獲勝：

選手應數度緊握雙拳示意表達復賽意願。如果選手在讀秒到“Yeo-dul (八)”以前仍無法表達繼續比賽的意願，主審應繼續讀秒至“A-hop(九)”與“Yeol(十)”，再宣告對手為優勝者。如果選手在讀秒到“Yeo-dul(八)”以後始表達復賽意願，則不能視為有效。即使選手於讀秒至“Yeo-dul (八)”以前表達復賽意願，若主審認為該選手已無能力復賽，主審可以繼續讀到“Yeol(十)”並宣告競賽結束。

(Explanation #5) (解釋#5)

When a contestant is downed by a powerful scoring blow and whose condition appears serious, the referee can suspend the count and call for first aid or do so in conjunction with the count.

當選手遭受強力衝擊出現擊倒的危急狀況，主審可以暫停讀秒，或是於急救時讀秒。

(Guideline for officiating) (執裁方針)

- i. The referee must not spend additional time confirming the contestant's recovery after counting to "Yeo-dul" as a result of failing to observe that condition during the administration of the count.

主審讀秒至“Yeo-dul (八)”之後，不應再浪費時間確認選手是否恢復，正確的方式應該是在讀秒同時觀察選手的狀態。

- ii. When the contestant clearly recovers before the count of "Yeo-dul" and expresses the will to resume and the referee can clearly discern the contestant's condition yet resumption is hampered by the requirement of medical treatment, the referee must first resume the match with the declaration of "Kye-sok" and immediately after declare "Kal-yeo" and "Kye-shi" and then follow the procedures of Article 19.

當選手在讀秒至“Yeo-dul (八)”之前已很清楚的恢復了意識，並表示出復賽意願，而主審亦可清楚的確認該選手的狀況，但是因醫療救護的影響仍處於無法復賽之狀態，此時，主審應先宣告“Kye-sok” (繼續)，接著立即宣告“Kal-yeo(離開)”與“Kye-shi(計時)”，再進行本競賽規則第 19 條之程序。

## Article 19 Procedures of suspending the match 第 19 條 暫停競賽的處理程序

1. When a contest is to be stopped due to the injury of one or both contestants, the referee shall take the measures prescribed below. However, in a situation which warrants suspending the contest for reasons other than an injury, the referee shall declare “Kal-yeo (break)” and resume the contest by declaring “Kye-sok (continue)”.  
當一方或雙方選手因受傷而中斷競賽時，主審應採取以下措施，然而，若暫停競賽的原因非受傷等因素，主審應宣告“Kal-yeo (離開)”，再宣告“Kye-sok (繼續)”恢復競賽。
  - 1.1 The referee shall suspend the contest by declaration of “Kal-yeo” and order the recorders to suspend the time.  
主審應宣告“Kal-yeo(離開)”，指示記錄人員暫停時間。
  - 1.2 The referee shall allow the contestant one minute to receive first aid by the commission doctor; the referee may allow team doctor to treat first aid if the commission doctor is not available or if it is deemed necessary.  
主審應允許選手在一分鐘內接受委任醫生緊急治療；如果委任醫生不在或有其必要，主審可以允許隊醫進行急救處理。
    - 1.2.1 The commission doctor may request more time (up to 2 minutes) if necessary.  
如有必要，委託醫生可以要求更多時間(最多 2 分鐘)
    - 1.2.2 If there is no commission doctor, team doctor or medical chairman available, any doctor (or medical associate) near competition mat can be requested to provide the athlete with first aid.  
如果委任醫生、隊醫或醫療主席不在現場，可以要求任何醫生(或醫療助理)在比賽地墊附近為運動員提供急救。
- 1.3 If an injured contestant cannot return to the match after one minute the referee shall declare the other contestant winner.  
如果選手於一分鐘後無法繼續比賽，主審應宣告其對手為優勝者。
- 1.4 In case resumption of the contest is impossible after one minute, the contestant causing the injury by a prohibited act to be penalized by “Gam-jeom” shall be declared the loser.  
如果選手於一分鐘後無法繼續比賽，是因為對手以違規行為造成的傷害並遭判罰“扣分(Gam-jeom)”的選手，將被宣告落敗。
- 1.5 In case both the contestants are knocked down and are unable to continue the contest after one minute, the winner shall be decided upon points scored before the injuries occurred.  
如果雙方選手都被擊倒並且於一分鐘之後都無法繼續比賽，則由擊倒前的分數決定優勝者。
- 1.6 If the referee determines a contestant’s pain is caused only by a bruise the referee shall declare “Kal-yeo” and give a command to resume the match with the call, “stand-up”. If the contestant refuses to continue the match after the referee gives the command “stand up” three times, the referee shall declare the match ‘Referee Stops Contest’.

如果主審認定選手僅是輕微擦撞的疼痛，應宣告“離開(Kal-yeo)”，再宣告“stand-up(起身)”  
如果選手拒絕繼續比賽，主審於宣告三次“stand-up(起身)”指令之後，主審應宣告‘主審停賽(RSC)’之裁決。

- 1.7 If the referee determines a contestant has received an injury such as broken bone(s), dislocation, sprain ankle(s), and/or bleeding, the referee shall allow the contestant to receive a first aid treatment for one minute after “Kye-shi”. The referee may allow the contestant to receive first aid treatment even after giving the commanding “stand-up” if the contestant is determined to be injured in one of the categories above.

如果主審認定選手已經受傷，例如骨折、脫臼、足踝扭傷或出血，即便主審在宣告“stand-up(起身)”指令之後，如發現選手受到上述類別之傷害，應於宣告“Kye-shi (計時)”，允許選手接受一分鐘的急救處理。

- 1.8 Stopping the match due to injury: If the referee determines a contestant has received an injury such as broken bone(s), dislocation, sprain ankle(s), and/or bleeding, the referee shall consult with the chairperson of the Medical Committee or the commissioned doctor assigned by the chairperson. If a contestant is re-injured in the same manner, the chairperson of the Medical Committee or the commission doctor assigned by the chairman may advise the referee to stop the match and declare the injured the loser.

因傷停賽: 如果主審認定選手已經受到了傷害，例如骨折、脫臼、足踝扭傷或出血，應諮詢醫務委員會主席或委任醫生。如果選手因相同的方式再次受傷，醫療委員會主席或是委任醫生可能會建議主審停止競賽，並宣告傷者落敗。

---

#### (Explanation #1) (解釋#1)

When the referee determines that the competition cannot be continued due to injury or any other emergency situation, he/she may take the following measures:

當主審認定競賽因受傷或其他任何緊急情況無法繼續下去，應採取以下措施。

- i. If the situation is critical such as a contestant losing consciousness or suffering from a severe injury and time is crucial, first aid must be immediately directed first and the match must be closed. In this case, the result of the match will be decided as follows.

如果情況危急，例如選手喪失意識或受傷嚴重且時間至關重要，第一應立刻急救且競賽必須結束，於此情況下，競賽結果將依下列方式決定:

- The contestant causing the injury shall be declared the loser if the outcome was the result of a prohibited act to be penalized by “Gam-jeom”.

以違規行為造成傷害結果遭判罰“扣分(Gam-jeom)”者，應裁定落敗。

- The incapacitated contestant shall be declared the loser if the outcome was the result of a legal action or accidental, unavoidable contact.

若意外是由於合法攻擊的動作、無法避免的接觸所造成的結果，無法競賽的選手應被裁定落敗。

- If the outcome was unrelated to the match contents, the winner shall be decided by the match score before suspension of the match. If the suspension occurs before the end of the first round, the match shall be invalidated.

若受傷原因與競賽無關，應依據競賽暫停之前的比分來決定優勝者。如果是在第一

回合結束之前暫停比賽，則該場競賽將被視為無效。

- ii. If first aid treatment is need for an injury, the contestant can receive necessary treatment within one minute after the declaration of “Kye-shi”.

如果傷害需要急救處理，選手可以在宣告“Kye-shi (計時)”後一分鐘內獲得必要的治療

- Order to resume the match: It is the decision of the center referee, after consultation with the Commission Doctor, whether or not it is possible for the contestant to resume the match. The referee can anytime order the contestant to resume the match within one minute. The referee can declare any contestant who does not follow the order to resume the match the loser of the contest.

責令繼續比賽: 主審與委任醫生協商後，可決定選手是否能夠在一分鐘內繼續比賽。主審可以宣告不按其指示繼續比賽的選手落敗。

- While the contestant is receiving medical treatment or is in the process of recovering, 40 seconds after the declaration of “Kye-shi”, the referee begins to loudly announce the passage of time in five second intervals. When the contestant cannot return to the Contestant’s Mark by the end of the one minute period, the match results must be declared.

選手接受治療或正在恢復過程中，主審自宣告“Kye-shi (計時)”後四十秒開始，應每隔五秒大聲提示時間。如果選手在一分鐘時限內無法回到參賽者的位置，主審裁判應裁定競賽結果。

- After the declaration of “Kye-shi”, the one minute time interval must be counted from the moment the commission doctor enter the mat or after waiting for commission doctor up to 10 seconds if not readily available in the mat. However, when the doctor’s treatment is required but the doctor is absent or additional treatment is necessary, the one minute time limit can be suspended by the judgment of the referee.

主審宣告“Kye-shi (計時)”必須從委託醫生進入墊子的那一刻起或不容易抵達地墊時等待委託醫生達 10 秒起計算一分鐘的時間。然而，當需要醫生治療但是醫生不在或需要更進一步的治療是必要時，主審可以決定是否暫停一分鐘的時間限制。

- If resumption of the match is impossible after one minute, the decision of the match will be determined according to sub-article “i” of this article.

如果在一分鐘之後無法復賽，該場競賽的裁定應根據本解釋條文之 i 項執行

- iii. If both contestants become incapacitated and are unable to resume the match after one minute or urgent conditions arise, the match result is decided according to the following criteria:

如果雙方選手在一分鐘之後皆無能力復賽或是情況危急，該場次競賽之結果應根據下列準則判定:

- If the outcome is the result of a prohibited act to be penalized by “Gam-jeom” by one contestant that person shall be the loser。

以違規行為造成對手受傷並遭判罰“Gam-jeom(扣分)”之選手，應裁定其落敗。

- If the outcome was not related to any prohibited act to be penalized by “Gam-jeom”, the result of the match shall be determined by the match score at the time of suspension of the match. However, if the suspension occurs before the end of the first round, the match shall be invalidated and the Organizing Committee will determine an appropriate time to re-contest the match. The contestant who cannot resume the match shall be deemed to have withdrawn from the match.

如果受傷非關違規行為判罰“Gam-jeom(扣分)”之條件因素，應依據競賽暫停之前

的比分來決定優勝者。如果是在第一回合結束之前暫停比賽，該場競賽將被視為無效。競賽籌備會應決定重新比賽的適當時間，無法復賽的選手將被視為棄權。

- If the outcome is the result of prohibited acts to be penalized by “Gam-jeom” by both contestants, then both contestants shall lose .

如果受傷因素為雙方選手之違規行為並遭判罰“Gam-jeom(扣分)”，雙方選手都應裁定落敗。

(Explanation #2) (解釋#2)

The situation which warrants suspending the match beyond the above-prescribed procedures shall be treated as follows.

上述暫停競賽處理程序以外的情況應作如下處置:

- i. When uncontrollable circumstances require suspension of the match, the referee shall suspend the match and follow the directives of the Technical Delegate.  
如遭不可抗力之情況必須中斷競賽，主審應停止競賽並遵循技術代表的指令。
- ii. If the match is suspended after the completion of the second round, the outcome shall be determined according to the match score at the time of suspension.  
如果競賽中止於第二回合後，勝負裁定取決於競賽中斷前雙方選手之比分。
- iii. If the match is suspended before the conclusion of the second round, a rematch shall, in principle, be conducted and shall be held in three rounds.  
如果競賽中斷於第二回合結束之前，原則上應安排進行三回合的重賽。

## Article 20 Technical Officials 第 20 條 技術官員

### 1 Technical Delegate (TD)

技術代表(TD)

- 1.1 **Qualification:** WT President shall appoint TD among members of WT technical committee for WT promoted championships upon recommendation of WT Secretary General.

資格：WT 主席在 WT 秘書長建議下由 WT 技術委員會成員中任命技術代表。

- 1.2 **Roles:**TD is responsible to ensure that WT Competition Rules are properly applied and preside over the Head of Team meeting and drawing of lots session. TD approves the result of draw, weigh-in and competitions before it being officialized. TD has the right to make final decisions on competition area and overall technical matters on competitions in consultation with Competition Supervisory Board. TD shall make final decisions on any matters pertaining to competitions not prescribed in Competition Rules. TD serves as the Chairman of Competition Supervisory Board. TD is responsible for reporting of event evaluation

角色:TD 負責確保 WT 競賽規則被正確應用，並主持領隊會議和抽籤會議。TD 在正式公布之前，核准抽籤、過磅和競賽結果。TD 有權與競賽管理委員會協調，就競賽領域及競賽整體技術事宜作出最後決定。TD 須就競賽規則未規定的任何比賽事宜作出最終決定。TD 擔任競賽管理委員會主席，TD 負責報告活動評估結果。

### 2 Competition Supervisory Board (CSB) Member

競賽管理委員會(CSB)成員

- 2.1 **Qualification:** CSB members shall be appointed by the WT President upon recommendation of Secretary General from those who have sufficient experience and knowledge of taekwondo competitions.

資格：競賽管理委員會成員應經由世界跆拳道聯盟秘書長向世界跆拳道聯盟主席建議任命擁有足夠的跆拳道競賽經驗與知識之人選。

- 2.2 **Composition:** CSB shall consist of one Chairperson and no more than 4 members at WT-promoted championships. Chairpersons of WT Games Committee, WT Referee Committee, and WT Medical Committee and WT Athlete Committee shall be included in CSB as ex-officio members. The composition, however, may be adjusted by the President, if necessary.

組成：由世界跆拳道聯盟所主辦的錦標賽之競賽管理委員會應由一名主席與六位以內的成員組成。世界跆拳道聯盟競賽委員會、裁判委員會與醫務委員會以及運動員委員會之主席，應列為競賽管理委員會之當然成員。然而，如為必要，世界跆拳道聯盟主席可以調整成員組合。

- 2.3 **Roles:** CSB shall assist TD in competitions and technical matters and ensure the competitions are held in accordance with the schedule. CSB shall evaluate the performances of Review Jury and refereeing officials. CSB shall also concurrently act as the Extraordinary Sanctions Committee during competition with regard to competition management matters.

任務：競賽管理委員會應協助技術代表處理競賽事務與相關技術的問題，以確保競賽得以順利進行。競賽管理委員會主要負責評估陪審與裁判人員的表現。競賽管理委員於競賽過程中亦兼任臨時制裁委員會以處理關於管理競賽方面的事務。

### 3 Refereeing officials

#### 裁判人員

#### 3.1 Qualification: Holders of International Referee Certificate registered by the WT

資格：世界跆拳道聯盟登錄之國際裁判證書持有者。

#### 3.2 Duties

職責：

##### 3.2.1 Referee

主審

3.2.1.1 The referee shall have control over the match.

主審應掌控整場競賽之狀況。

3.2.1.2 The referee shall declare “Shi-jak”, “Keu-man”, “Kal-yeo”, “Kye-sok”, “Kye-shi”, “Shi-gan”, winner and loser, deduction of points, penalty, and retiring. All the referees’ declarations shall be made after the results are confirmed.

主審應宣告 “Shi-jak(開始)”、“Keu-man(停止)”、“Kal-yeo(離開)”、“Kye-sok(繼續)”、“Kye-shi(計時)”、“Shi-gan(時間)”等指令，宣告勝方與負方、扣分、判罰與退場，於比賽結束後確認所有裁判的判決。

3.2.1.3 The referee shall have the right to make decisions independently in accordance with the prescribed rules.

主審依據競賽規則做獨立自主的裁決。

3.2.1.4 In principle, the center referee shall not award points. However, if one of the corner judges raises his/her hand because a point was not scored, then the center referee will convene a meeting with the judges. If it was found that two corner judges request for change of the judgment, the referee must accept and correct the judgment (in case of 1 referee + 3 judges). In a two corner judge setting, the result of the scoring can be revised when two persons among two judges and the referee agree to do so.

原則上，主審不計分。然而，如果有副審因為顯示得分而舉手示意，主審應召集所有的副審討論若有兩位副審要求更改判決，主審應接受更正判決(一位主審+三位副審的情況)。在兩位副審的編制下，可以在一位主審與二位副審中有兩位裁判同意的情況下更正計分結果。

3.2.1.5 In case as defined by the Article 15, the decision of superiority shall be made by refereeing officials after the end of four (4) rounds when necessary.

在競賽規則第15條所定義的情況下，如為必要，裁判人員應當於第四回合結束後進行優勢判定。

##### 3.2.2 Judges

副審

3.2.2.1 The judges shall mark the valid points immediately.



副審應立即記下有效得分。

- 3.2.2.2 The judges shall state their opinions forthrightly when requested to do so by the referee.

主審詢問意見時，副審應坦率的陳述意見。

### 3.2.3 Review Jury (RJ)

陪審

- 3.2.3.1 RJ shall review an instant replay and inform the referee of the decision within thirty (30) seconds

RJ 應審查錄像審議，並在三十 (30) 秒內將判決通知裁判

### 3.2.4 Technical Assistant

技術助理

- 3.2.4.1 TA shall keep monitoring scoreboard during the contest if the scoring, penalties and timing are correctly publicized, and immediately notify the referee of any problematic issue in this regard.

技術助理應監控競賽過程中保持比賽的計分、宣告判罰與時間是否正確的，若比賽過程中出現任何相關問題應立即通知主審。

- 3.2.4.2 TA shall notify the referee of starting or stopping the contest in close communication with system operator and recorder.

技術助理應與系統操作與紀錄人員保持溝通，以提醒主審開始或停止競賽。

- 3.2.4.3 TA manually records all scores, penalties and IVR result in TA paper.

技術助理應紀錄所有的分數、判罰與錄像審議(IVR)結果於技術助理的報表上

## 3.3 Composition of refereeing officials per court

各競賽場地裁判人員的組成

- 3.3.1 The officials' squad is composed of one (1) referee and three (3) judges.

由一位主審與三位副審組成。

- 3.3.2 The officials' squad is composed of one (1) referee and two (2) judges

由一位主審與二位副審組成。

## 3.4 Assignment of refereeing officials

裁判人員的指派

- 3.4.1 The assignment of the referees and judges shall be made after the contest schedule is

fixed.

於賽程確認後再予以指派主審與副審。

- 3.4.2 Referees and judges with the same nationality as that of either contestant shall not be assigned to such a contest. However, an exception can be made for the judges when the number of refereeing officials is insufficient.

於同場賽事中，主、副審不得與競賽選手具有相同的國籍，然而，在裁判人員不足的情況下，得指派相同國籍的裁判擔任副審。

- 3.5 Responsibilities for decisions: Decisions made by the referees and judges shall be conclusive and they shall be responsible to the Competition Supervisory Board for the content of those decisions.

裁決責任: 主審與副審之判決為最終結果，並且必須向競賽管理委員會對該判決的內容負責。

- 3.6 Uniforms  
制服

- 3.6.1 The referees and judges shall wear the uniform designated by the WT.

主審與副審應穿著世界跆拳道聯盟所指定的制服

- 3.6.2 The refereeing officials shall not carry or take any materials to the contest area which might interfere with the contest. Use of mobile phones by refereeing officials in the field of play may be restricted, if necessary.

裁判人員進入競賽場地時不得攜帶任何可能影響競賽之物品。必要時裁判人員於競賽場地使用手機可能會被限制。

- 4 Recorders: The recorder shall time the contest, periods of time-out, and suspensions, and also shall record and publicize the awarded points, and/or penalties.

記錄人員: 記錄人員負責競賽計時、暫停時間、終止競賽，以及記錄並公佈比分與判罰的紀錄。

---

(Explanation #1) (解釋#1)

Refereeing officials must stay in a separate hotel to avoid any contact with team officials. The hotel should be located less than 20 minutes distance by car from the venue.

裁判官員必須住在單獨的酒店，以避免與代表隊隊職員有任何接觸。酒店距離比賽場地不到 20 分鐘車程。

(Interpretation) (說明)

The details of the refereeing official's qualifications, duties, organization, etc. shall follow the WT Regulations on the Administration of International Referees.

裁判人員的資格、職責與組織等細節，應依循世界跆拳道聯盟國際裁判的行政法規。

(Interpretation) (說明)

TD may replace or penalize the refereeing officials in consultation with CSB in the event that refereeing officials have been wrongly assigned, or when it is judged that any of the assigned refereeing officials have

unfairly conducted the contest or made unjustifiable mistakes repeatedly.

技術代表在與競賽管理委員會諮詢下，可以更換或懲處指派錯誤、執裁不公或造成多次不合理錯誤之裁判人員。

(Guideline for officiating) (執裁方針)

In case that each judge awards different score respectively to the legal attack on the head, for instance, one judge gives one point, another gives two and the other gives no point, and that no point is recognized as a valid one, or in the case that the recorder makes mistakes in timing, scoring or penalties, any of the judges may indicate the mistake and ask for confirmation among the judges. Then, the referee may declare “Kal-yeo” (break) to stop the contest and gather the judges to ask for statements. After discussion, the referee must publicize the resolution. In the case that a coach requests for video review for the same case that one of the judges requests for a meeting between refereeing officials, the referee shall first gather judges before taking the request from coach. If it has been decided to correct the decision, the coach shall remain seated without using appeal quota. If the coach still stands and request for video review, the referee shall take the coach’s request.

如果副審對於合法攻擊頭部所給的分數不一致，例如一位副審給 1 分，另一位給 2 分，其他沒給分，因而沒有被視為有效得分，或是計時、計分獲判罰錯誤的情況下，任何一位裁判人員 都可以指出此類錯誤，並要求重新確認。隨後主審可以宣告“Shi-gan (時間)” 暫停競賽時間，並召集副審確認，討論後主審應公布結果。同一案例如遇指導教練提出錄影審議與副審要求確認同時發生的情況下，主審應先召集副審。如果決定更正判決，該名指導教練應就座並不提出錄像審議。若指導教練仍站立並要求錄影審議，主審應接受其要求。

## Article 21 Instant Video Replay 第 21 條 即時影像重播

- 1 In case there is an objection to a judgment of the refereeing officials during the contest, the coach of a team can make a request to the center referee for an immediate review of the video replay. The coach can only request video review for followings;

如果於競賽過程中對裁判人員的判決有異議，指導教練可以提請即時錄像審議。指導教練只能針對下列情況提出即時錄像審議

- i) Penalties against the opponent for instances of falling down or crossing the boundary line or attacking the opponent after “Kal-yeo” or attacking the fallen opponent  
給予對手的判罰，限於出界、倒地、離開後攻擊及攻擊倒地選手
- ii) Technical point  
技術分數
- iii) Any penalty against own contestant  
任何己方選手的判罰
- iv) Any mechanical malfunction or error in time management. In case of appeal for PSS mechanical malfunction, the coach may request to the center referee for a testing of the PSS at any time during the 2<sup>nd</sup> and/or the 3<sup>rd</sup> round. However, if the PSS mechanical function is properly working, the coach’s appeal quota shall be forfeited. As well as this coach’s appeal is considered to be a misconduct of coach that “Gam-jeom” shall be given to own contestant in accordance with Article 14.4.1.3 ‘Following Misconducts of contestant of coach’. This only applies to the ‘Best of 3’ System.  
任何技術問題或時間管理錯誤。如果 PSS 電子護具系統出現問題，教練可以在第 2 回合和第 3 回合期間的任何時間要求主審對 PSS 進行測試。但是，如果 PSS 測試正常，教練的申訴額度將被沒收。該教練的申訴行為被認為是教練的不當行為，應根據第 14.4.1.3 條“，參賽者的教練不當行為”給予自己的參賽者“Gam-jeom”判罰。這僅適用於“3 戰 2 勝制”賽制。
- v) When referee forgot to invalidate point(s) after “Gam-jeom” was given for prohibited act  
當主審給予違規行為判罰後忘記取消分數
- vi) Wrong identification of fist attacking contestant by judge  
副審對正拳得分給予錯誤選手
- vii) Head kick that is not scored  
頭部踢擊未計分

- 2 When coach appeals the center referee will approach the coach and ask the reason for the appeal. Any appeal shall not be admissible on any points scored by foot or fist attacks on the trunk or foot attack on trunk PSS. Coach may request instant video replay for head kick regardless of using head PSS. The scope of instant video replay request is limited to the only one action which has occurred within five (5) seconds from the moment of the coach’s request. Once the coach rises the blue or red card to request for instant video replay, it will be considered that the coach has used his/her allocated appeal under any circumstance unless the judge’s meeting satisfies the coach.

當指導教練申訴時，主審應走近指導教練，並詢問申訴理由。經由電子護具計分系統所採認的腳部攻擊得分或是以正拳攻擊軀幹得分，皆不得申訴。使用電子頭盔時教練可提出頭部踢擊申訴。即時錄像審議的範圍僅限於指導教練針對已發生的一個動作，於五秒鐘內提出申訴請求。一旦指導教練舉出紅色或藍色卡要求即時錄影重播，都視為其使用申訴的限額，除非指導教練滿意副審要求召集後的結果。

- 3 Referee shall request the Review Jury to review the instant video replay. Review Jury, who is not of the same nationality as the contestants, shall review the video replay.

主審應要求陪審進行即時錄像審議，陪審必須與選手為非相同國籍者，方可進行即時錄像審議。

- 4 After review of the instant video replay, the Review Jury shall inform the center referee of the final decision within 30 seconds after receiving the request.

檢視錄像後，陪審應於接受請求即時錄像審議 30 秒之內將裁決告知主審。

- 5 Coach shall be allocated with one (1) appeal to request an instant video replay request per each contest. However, based on the size and level of the Championships, the Technical Delegate may decide the number of appeal quota during the head of team meeting. If the appeal is successful and the contested request is corrected, the coach shall retain the appeal right for the pertinent contest.

指導教練每場比賽獲得一次替選手申訴額度。然而，依據競賽的規模與層級，技術代表可以於領隊會議中決定該次比賽申訴次數的限額。教練提出申訴如果成功，該場次保有申訴權利。

- 6 The decision of the Review Jury is final; no further appeals during the contest or protest after the contest will be accepted.

陪審的決議為最終裁決，競賽中或競賽後將不再接受申訴。

- 7 In the case that there is a clear erroneous decision from the refereeing officials on identification of the contestant or errors in the scoring system, any of the refereeing officials shall request for review and correct the decision at any time during the contest. If correction is decided, it has to take place ahead of the following contest for winner of the contest in question.

若裁判人員於識別選手的一部分或計分系統有明顯的錯誤，於此情況下，不論是在競賽中的任何時候，任何裁判人員應要求進行審議並更正結果。如果決定更正，則必須在下一場比賽之前進行更正相關比賽的獲勝者。

- 8 In the case of a successful appeal, the Competition Supervisory Board may investigate the contest at the end of the competition day and take disciplinary action against the concerned refereeing officials, if necessary.

若申訴成功，競賽管理委員會於當日競賽結束後進行調查，必要時將對該裁判人員進行紀律懲處。

- 9 In any time during the round, any of the judges can ask for adding or removing technical points regardless of coach's appeal quota

在回合中的任何時間，無論指導教練沒有申訴配額時，副審可以要求即時錄像審議加入或取消技術分。

- 10 In the tournament where instant video replay system is not available, the following protest procedure will be applied.

若競賽未使用錄影重播系統，應以下列的程序進行抗議申訴。

- 10.1. In case there is an objection to a referee judgment, an official delegate of the team must submit an application for re-evaluation of decision (protest application) together with the non-refundable protest fee of US\$200 to the Board of Arbitration (Competition Supervisory Board) within 10 minutes after pertinent contest.

若對主審之裁決有異議，代表隊代表應於該場競賽結束後十分鐘之內，提請重新評估結果，並繳交無退費之抗議金 200 元美金於給仲裁委員會(競賽管理委員會)。

- 10.2. Deliberation of re-evaluation shall be carried out excluding those members with the same nationality as that of contestant concerned, and resolution on deliberation shall be made by majority.

重新評估審議應排除與選手相同國籍之成員，審議決議應以多數決決議。

- 10.3. The members of the Board of Arbitration (Competition Supervisory Board) may summon the refereeing officials for confirmation of events.

仲裁委員會委員可召集當事裁判人員確認事件。

- 10.4. The resolution made by the Board of Arbitration (Competition Supervisory Board) will be final and no further means of appeal will be applied.

仲裁委員會(競賽管理委員會)之裁決為最終之決定，之後不再受理任何形式之申訴。

- 10.5. Deliberation procedures are as follows:

仲裁程序如下:

- 10.5.1. A coach or head of team from the protesting nation shall be permitted to make a brief verbal presentation to the Board of Arbitration in support of their position. The coach or head of team from the respondent nation shall be allowed to present a brief rebuttal.

允許抗議申訴之指導教練或領隊向仲裁委員會(競賽管理委員會)提出簡短的口頭陳述以說服支持其立場。應允許對方之指導教練或領隊向仲裁委員會(競賽管理委員會)進行簡短的反駁聲明。

- 10.5.2. After reviewing the protest application, the contest of the protest must be arranged according to the criterion of “Acceptable” or “Unacceptable”.

審查抗議申訴後，抗議的競賽應依據判定“可接受”或“不接受”之準則進行。

- 10.5.3. If necessary, the Board can hear opinions from the referee or judges.

必要時仲裁委員會可聽取主審與副審的意見

- 10.5.4. If necessary, the Board can review the material evidence of the decision, such as the written or visual recorded data.

必要時仲裁委員會可檢視判決證據，例如書面或影像紀錄資料。

10.5.5. After deliberation, the Board shall hold the secret ballot to determine a majority decision.

經審議後，仲裁委員會應進行不記名投票並依多數決決議。

10.5.6. The Chairperson will make a report documenting the outcome of the deliberation and shall make this outcome publicly known.

主席將審議結果記錄並匯整報告，並將結果公告週知。

10.5.7. Subsequent process following the decision:

裁決後之程序

10.5.7.1. Errors in determining the match results, mistakes in calculating the match score or misidentifying a contestant shall result in the decision being reversed.

競賽結果裁決錯誤：應撤銷競賽計分錯誤或誤認選手等錯誤的判決。

10.5.7.2. Error in application of the rules: When it is determined by the Board that the referee made a clear error in applying the Competition Rules, the outcome of the error shall be corrected and the referee shall be punished.

競賽規則引用錯誤：當仲裁委員會(競賽管理委員會)裁決裁判規則引用錯誤，應更正錯誤並處分裁判。

10.5.7.3. Errors in factual judgment: When the Board decides that there was a clear error in judging the facts such as impact of striking, severity of action or conduct, intention, timing of an act in relation to a declaration or area, the decision shall not be changed and the officials seen to have made the error shall be reprimanded.

在事實判斷上的錯誤：當競賽管理委員裁決有明顯錯誤判決的事實，例如踢擊的衝擊力、嚴重的行為意圖、宣告的時間行為或區域等，裁決不會進行更改，判決錯誤的裁判則應受到處分。

## Article 22 Deaf-Taekwondo 第 22 條 聽障跆拳道

This article outlines the modifications to the Competition Rules used for Deaf-Taekwondo. For matters not covered by Article 22 the WT Competition Rules will apply.

本條文概述之修改用以對應聽障跆拳道競賽規則。不屬於競賽規則第 22 條之事項亦將適用。

### 1. Qualification of athlete 選手資格

Contestant must have gone through classification procedures as outlined in the World Para-Taekwondo and Deaf- Taekwondo Classification Code and been assigned Sport Class and Sport Class Status

選手必須已經通過世界跆拳道聯盟帕拉跆拳道與聽障跆拳道分級規章制度所述之程序分類，並已被列為具有競技等級與競技等級狀態。

### 2. Weight Categories 量級區分

Olympic weight categories apply to competitions in Deaf-Taekwondo

奧林匹克運動會跆拳道競賽的量級區分適用於聽障跆拳道競賽。

### 3. World Deaf-Taekwondo Championships will be organized based on the most recent Standing Procedure of the World Deaf-Taekwondo Championships.

世界跆拳道聽障跆拳道錦標賽將根據其最新的聽障跆拳道錦標賽常設規程舉辦。



## Article 23 Sanctions 第 23 條 制裁

- 1 The WT President, Secretary General, or Technical Delegate may request that on-spot Extraordinary Sanctions Committee be convened for deliberation when inappropriate behaviors **may have been** committed by a coach, a contestant, official, and/or any member of a Member National Association.

世界跆拳道聯盟主席、秘書長或技術代表在指導教練、選手、官員或相關會員國協會的任何成員所犯下列的行為時，可以要求在現場的臨時制裁委員會召開會議進行審議。

- 2 The Extraordinary Sanctions Committee shall **investigate** the matter, and summon person(s) concerned for confirmation of events.

臨時制裁委員會應審議該事項，並可能傳喚相關當事人以確認事件。

- 3 The Extraordinary Sanctions Committee shall deliberate the matter and determine if disciplinary actions **are to be** impose. The result of deliberation shall be immediately announced to the public. **If there is a finding violation, a written decision including the relevant facts, rules, supporting evidence (such as witness statement), the sanction imposed, and rationale. shall be given to the sanctioned party as soon as reasonably practicable, and a copy should be included in the Technical Delegate's report**

特別制裁委員會應審議此事，並確定是否採取紀律行動。評議結果應當立即向公眾公佈。如果發現違規，則書面判決，包括相關事實、規則、支持證據（如證人陳述）、實施的制裁和理由。應在合理可行的情況下儘快提供給受制裁方，並應在技術代表的報告中包括一份副本

### 3.1 Potential violations on Conduct of a Contestant;

參賽選手潛在違規行為

- 3.1.1 Refusing the referee's command to complete the ending procedures of the match, including not participating in the declaration of the winner  
拒絕裁判的指令來完成競賽結束的程序，包括不參與宣告優勝者
- 3.1.2 Throwing his/her belongings (headgear, groves, etc.) as an expression of dissatisfaction with decision.  
丟擲個人的物品(護頭盔、隨身物件等)以表達不滿判決的表現
- 3.1.3 Not leaving the Competition area after the end of a match  
競賽結束後不離開競賽區
- 3.1.4 Not returning to a match after a referee's repeated command  
主審多次宣告指令後仍不復賽
- 3.1.5 Not complying with the Competition Official's ruling or command  
不遵守競賽官方正式的裁決或指令
- 3.1.6 Not complying with the Competition Management Officials reasonable instructions related to the orderly management of the event

不遵守競賽管理官員有關賽事秩序管理的合理指示

**3.1.7 Manipulation of scoring equipment, sensors or/and any part of a PSS**

操作 PSS 電子計分系統的設備、感應器或其他任何部分

**3.1.8 Any serious unsportsmanlike behavior during a match or aggressive misconduct toward competition officials.**

在競賽中發生任何違反運動道德的行為或是對競賽官員有不當的侵略性行為

**3.2 Potential violations on conduct of a coach, team official, or other members of a Member National Association;**

指導教練、選手、官員或是會員國協會其他成員可能的違規行為

**3.2.1 Complaining about or/and arguing against an official's decision during or after a round.**

於競賽過程中或之後抱怨或駁斥官員正式的裁決

**3.2.2 Arguing with the referee or other official(s)**

與裁判人員或其他官員爭論

**3.2.3 Violent behavior or remark toward officials, opponents or the opposing side, or spectators during a match**

在競賽中對官員、對手或對方，或是觀眾的暴力行為或言論

**3.2.4 Provoking spectators or spreading false rumor**

煽動觀眾或散佈虛假謠言

**3.2.5 Instructing athlete(s) to participate in misconduct, such as remaining in the competition area after a match**

指示選手參與不當行為，例如競賽結束後留在競賽區

**3.2.6 Violent behaviors such as throwing or kicking personal belonging(s) or competition material(s).**

暴力行為，例如投擲或踢擊屬於個人或競賽的器材

**3.2.7 Not following instructions of competition officials to leave the Field of Play or Venue**

不遵守競賽官員的指示，離開競賽場地或場館

**3.2.8 Any other serious misconducts toward competition officials**

任何其他對官員嚴重的不當行為

**3.2.9 Any attempt to bribe competition officials**

任何企圖行賄競賽官員的行為

- 4 Disciplinary actions: Disciplinary Actions issued by the Extraordinary Sanction Committee may vary according to the degree of the violation. The following sanctions may be given:

紀律處分：臨時制裁委員會做出的紀律處分，可以根據違規程度差異，給予下列之制裁：

- 4.1 Disqualification of the athlete  
取消選手之資格
- 4.2 Warning and order to issue official apology  
警告並責令發出正式道歉
- 4.3 Removal of Accreditation  
取消選手註冊卡
- 4.4 Ban from the Competition Venue  
禁止進入競賽場館
  - i) Ban for the day  
禁賽一天
  - ii) Ban for the duration of the Championships.  
競賽期間禁賽
- 4.5 Cancellation of Result  
成績取消
  - i) Cancellation of the match result and all related merits  
取消競賽成績與所有相關的積分
  - ii) Cancellation of WT Ranking points  
取消世界跆拳道聯盟的排名積分
- 4.6 Monetary fine of between \$100-to-\$5,000 US dollars per violation。  
罰款：每個違規介於 100 美元至 5,000 美元處分罰款  
本條款改至 4.6

- 5 The Extraordinary Sanctions Committee may recommend to the WT, **or WT at its own initiative may investigate and determine** that additional disciplinary actions be taken against the members /MNA involved, including but not limited to involved, including but not limited to longer-term suspension, lifetime ban, and/or additional monetary fines. **Such recommendation can be based on violations of the Competition Rules and Interpretations as well as violations of the WT Code of Ethics or other pertinent WT rules.**

特別制裁委員會可以向 WT 提出建議，或者 WT 可以主動調查並確定對涉及的成員/會員國採取額外的紀律處分，包括但不限於長期停權，終身禁令和/或額外的罰款。此類建議可以基於違反競賽規則和解釋以及違反 WT 道德準則或其他相關 WT 規則的行為

## Article 24 Other matters not specified in Competition Rules 第 24 條 其他規則中未明訂之事項

- 1 In the case that any matters not specified in the rules occur, they shall be dealt with as follows.

如遇任何規則中未明訂之事項發生的情況，應依下列方式處理：

- 1.1 Matters related to a contest shall be decided through consensus by the refereeing officials of the pertinent contest.

與競賽相關之事項，應通過該場競賽裁判人員協商做出一致的決定。

- 1.2 Matters not related to a specific contest throughout the Championships such as technical matters, competition matters, etc. shall be decided by the Technical Delegate.

不涉及整個錦標賽特定競賽的問題，例如技術事項與競賽事務，由技術代表決定之。

編譯：戴淑華

審查：中華民國跆拳道協會 競賽裁判委員會

召集人：王文賢

委員：林彬堯、劉祖望、吳榮仁、劉俊賢、周英嬌、  
竇鳳鳴、鄭遠歲、呂文玲

中華民國 112 年 2 月 8 日